

ETHICON

PART OF THE *Johnson & Johnson* FAMILY OF COMPANIES

PRODUCT CATALOG

Sutures

Hernia Solutions

Biosurgicals



Our Credo

We believe our first responsibility is to the doctors, nurses and patients,
to mothers and fathers and all others who use our products and services.

In meeting their needs everything we do must be of high quality.

We must constantly strive to reduce our costs
in order to maintain reasonable prices.

Customers' orders must be serviced promptly and accurately.

Our suppliers and distributors must have an opportunity
to make a fair profit.

We are responsible to our employees,
the men and women who work with us throughout the world.

Everyone must be considered as an individual.

We must respect their dignity and recognize their merit.

They must have a sense of security in their jobs.

Compensation must be fair and adequate,
and working conditions clean, orderly and safe.

We must be mindful of ways to help our employees fulfill
their family responsibilities.

Employees must feel free to make suggestions and complaints.

There must be equal opportunity for employment, development
and advancement for those qualified.

We must provide competent management,
and their actions must be just and ethical.

We are responsible to the communities in which we live and work
and to the world community as well.

We must be good citizens — support good works and charities
and bear our fair share of taxes.

We must encourage civic improvements and better health and education.

We must maintain in good order
the property we are privileged to use,
protecting the environment and natural resources.

Our final responsibility is to our stockholders.

Business must make a sound profit.

We must experiment with new ideas.

Research must be carried on, innovative programs developed
and mistakes paid for.



















New equipment must be purchased, new facilities provided
and new products launched.

Reserves must be created to provide for adverse times.

When we operate according to these principles,
the stockholders should realize a fair return.

Johnson & Johnson

Table of contents

Selection & Use of Surgical Needles		5
Antibacterial Plus Suture Technology		17
VICRYL* Rapide (Polyglactin 910) Braided		19
MONOCRYL* (Poliglecaprone 25) Monofilament		25
MONOCRYL* Plus (Poliglecaprone 25) Antibacterial Monofilament		31
VICRYL* (Polyglactin 910) Braided and Monofilament		37
VICRYL* Plus (Polyglactin 910) Antibacterial Braided		53
PDS* II (Polydioxanone) Monofilament		63
PDS* Plus (Polydioxanone) Antibacterial Monofilament		73
PROLENE* (Polypropylene) Monofilament		79
PRONOVA* (Poly(hexafluoropropylene-VDF)) Monofilament		93
ETHILON* (Polyamide 6) Monofilament		97
ETHIBOND* Excel (Polybutylate coated polyester) Braided		107
MERSILENE* (Polyester) Braided and Monofilament		117
NUROLON* (Polyamide 6/6) Braided		123
SILK Braided / Virgin Silk		127
STEEL WIRE Braided and Monofilament		135
HERNIA SOLUTIONS		141
BIOSURGERY		155
OTHER PRODUCTS		159
Product Code Index		181

Our trademarks

ABSOLOK
ATRALOC
BLAKE
CONTROL RELEASE
CS ULTIMA
DERMABOND
EASY ACCESS
ENDOKNOT
ENDOLOOP
ENDOPATH
ENDOPOUCH
ETHALLOY
ETHIBINDER
ETHIBOND
ETHICON
ETHI-ENDO-NAHT
ETHIGUARD
ETHILON
ETHILOOP
ETHIPIN
ETHIZIP

ETHISORB
ETHILOCK
ETHITOUCH
HEMO-SEAL
LIGACLIP
LIGAPAK
MERSILENE
MERSILK
MERSUTURES
MICROPOINT
MONOCRYL
MULTIPASS
NUROLON
OMNEX
PDS
PERMA-HAND
PHYSIOMESH
POWERSTAR
PRIME
PRINEO
PROLENE

PRONOVA
PROCEED
PROXIMATE
PROXI-STRIP
QUIXIL
RELAY
SABRELOC
SECURESTRAP
SLIM BLADE
SUTUPAK
SURGICEL
SPONGOSTAN
STRATAFIX
SURGIFLO
TAPERCUT
ULTRAPRO
VICRYL
VISI-BLACK
VYPRO

Selection and use of surgical needles

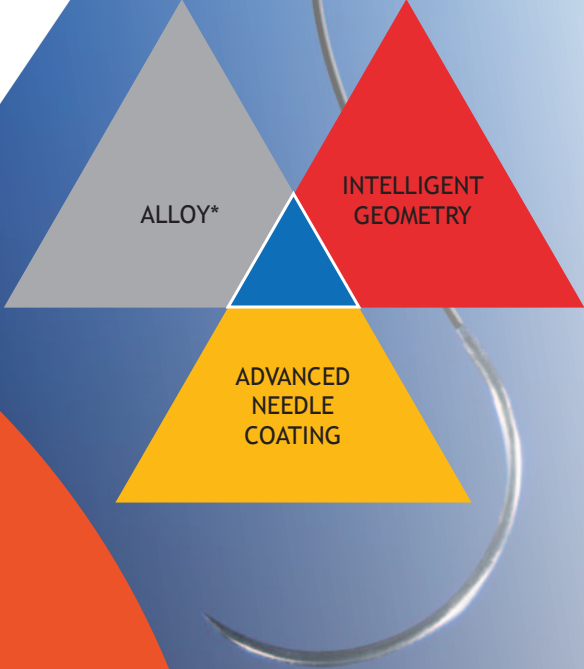

Intelligent Geometry

A Unique Needle Range

ETHIGUARD Blunt Point Needles

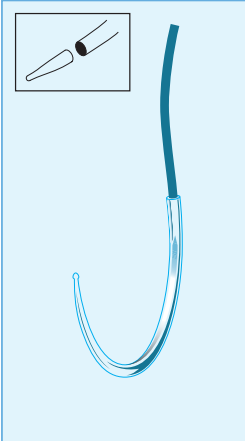

Improving safety

Taper Point Needles

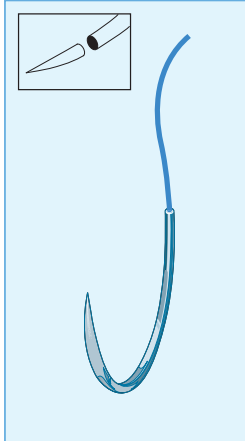

Gentle separation of fibrous tissue

BV Needles

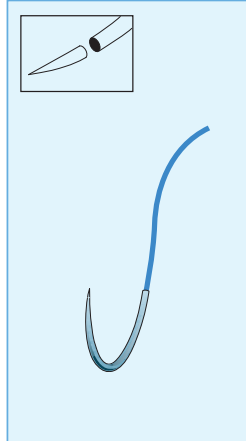

Consistency pass after pass

VISI-BLACK Needles

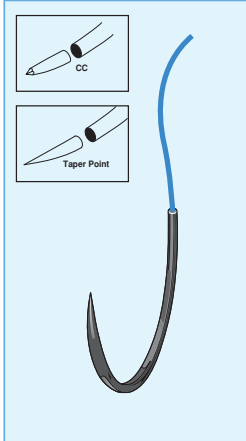

Visibility is their strength

CC Needles

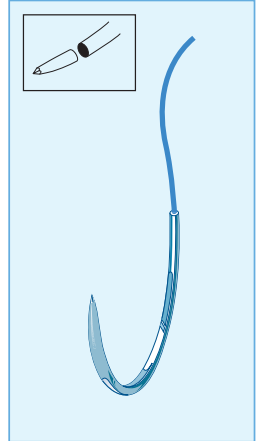

Easy penetration of calcified coronary tissues

HEMO-SEAL Needle Sutures

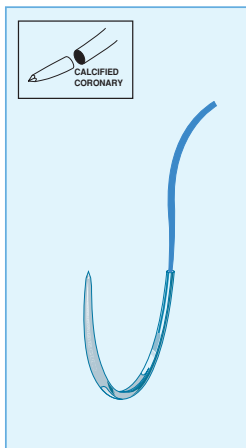

A fitting choice for vascular surgery

MULTICURVE Needles

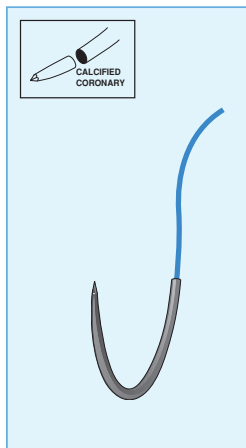

For confined access procedures

TAPERCUT Needles

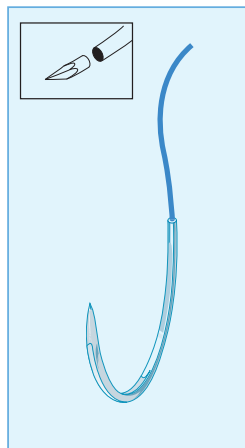

Easy penetration of dense tough tissue

PRIME Needles

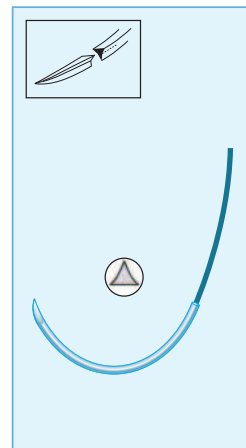

Excellence in skin closure

Anatomy of a Needle

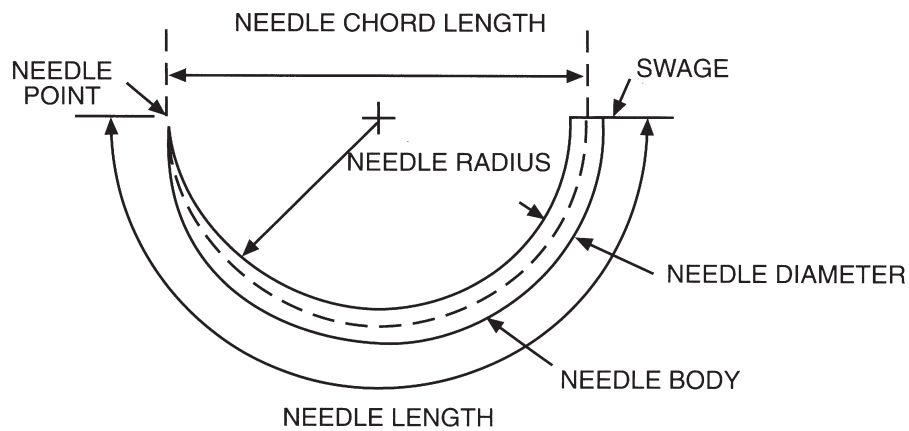



Needle Point Needles can taper to a point or have cutting edges.

Taper Ratio Longer points for improved penetration.

Needle Body

 **Needle flat** Flatted section for stability in the needle holder.

 **Ribs** In larger needles there is a ribbed section to provide a secure grip.

 **Square Body** Needles can also have a square body for increased strength.

Swage A hole is drilled into the end of the wire and the material is attached into this hole. For premium needles the needles are laser drilled which provides a smooth transition between needle and material thus reducing tissue trauma.

Needle Shape

The choice of needle shape is frequently governed by the accessibility of the tissue to be sutured, and normally the more confined the operative site the greater the curvature required. The basic shapes involved are:

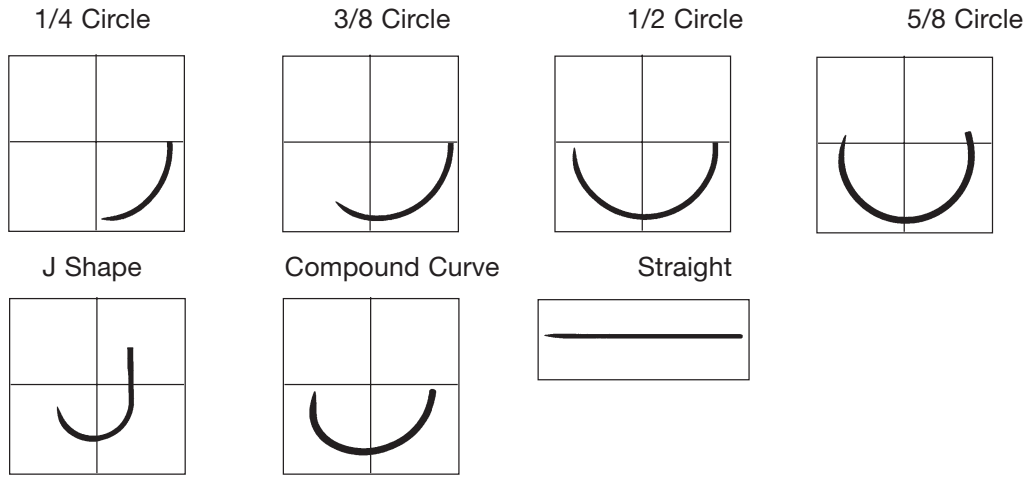

Round Bodied needles

Round Bodied needles are designed to separate tissue fibres rather than cut them. They are used either for soft tissue or in situations where easy splitting of tissue fibres is possible. After the passage of the needle, the tissue closes tightly round the suture material, thereby forming a leak-proof suture line which is particularly vital in Intestinal and Cardio-vascular surgery.

Round Bodied needles are manufactured with different wire diameters according to the tissue to be sutured. For softer tissue such as bowel finer wire diameters can be used. Whereas for muscle or fascia heavier wire diameters are required.

TAPERPOINT Needle

This point profile is engineered to provide easy penetration of intended tissues. Forceps flats are formed in an area half way between the point and the attachment, Positioning the needle holder in this area confers extra stability on the needle being held, aiding precise placement of the sutures. Taper Point needles are available in a range of wire diameters and the finer diameters can be used for softer tissue in gastrointestinal or vascular procedures whereas heavier diameters are required for tougher tissue such as muscle.

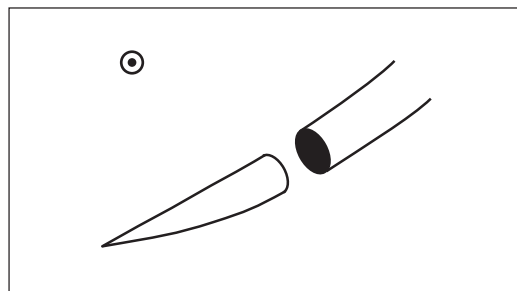

TAPERPOINT Plus

A modified point profile for most of our needles. In a modified profile, the tapered cross section immediately behind the tip has been flattened to an oval shape rather than a conventional round shape. This continues for several millimeters before merging into the conventional round bodied cross section. This design was developed to help facilitate improved separation of tissue layers.

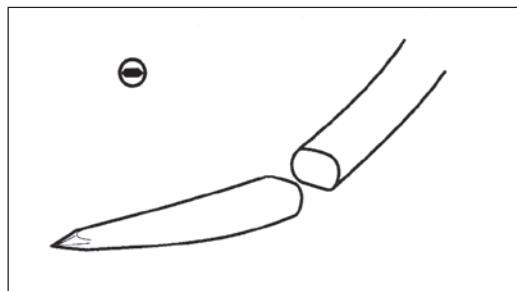

VISI - BLACK Needle

These black needles have been designed to give outstanding visibility against tissue and where blood is present in the operating field. The slim Taper Point design of the VISIBLACK Needle brings improved penetration properties and minimises tissue trauma.

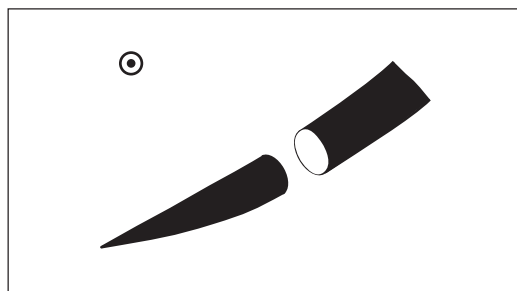

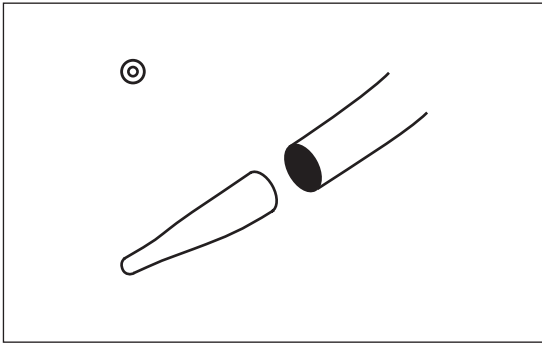

ETHIGUARD Blunt Point Needle

The needles has been designed to minimise the risk of needle stick injury. The ETHIGUARD Needle point is sharp enough to penetrate fascia and muscle but not skin. Virtually eliminating accidental glove puncture, the ETHIGUARD Needle can also be used for suturing friable tissue such as the liver.

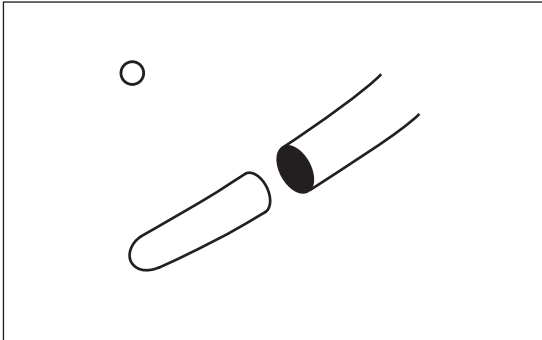

Blunt Point Needle

This needle has been designed for suturing extremely friable tissue such as the liver.

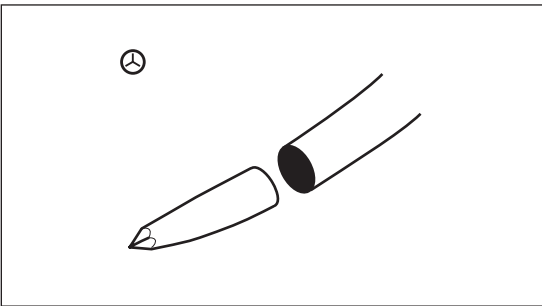

CC Needle

The unique point design of the CC Needle provides significantly improved penetration properties for the Cardiac / Vascular surgeon when suturing tough, calcified vessels. This is achieved with no increase in tissue trauma compared to the conventional round bodied needle. Squared body geometry, in addition to providing a stronger fine vascular needle, also means this needle is particularly secure in the needle holder.

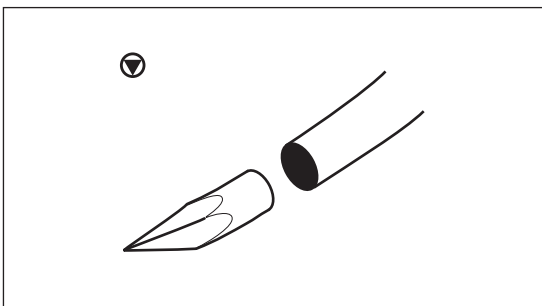

TAPERCUT Needle

This needle combines the initial penetration of a cutting needle with the minimised trauma of a round bodied needle. The cutting tip is limited to the point of the needle, which then tapers out to merge smoothly into a round cross section.

Cutting Needles - for Fibrous Tissue

Cutting needles are required wherever fibrous or dense tissue needs to be sutured.

Reverse Cutting Needle

The body of this needle is triangular in cross section, having the apex cutting edge on the outside of the needle curvature. This improves the strength of the needle and particularly increases its resistance to bending.

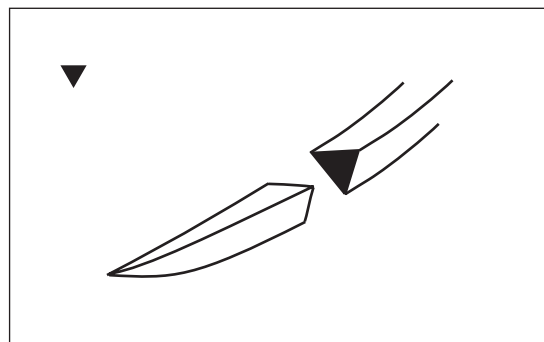

TROCAR POINT Needle

Based on the traditional TROCAR POINT, this needle has a strong cutting head which then merges into a robust round body. The design of the cutting head ensures powerful penetration, even when deep in dense tissue.

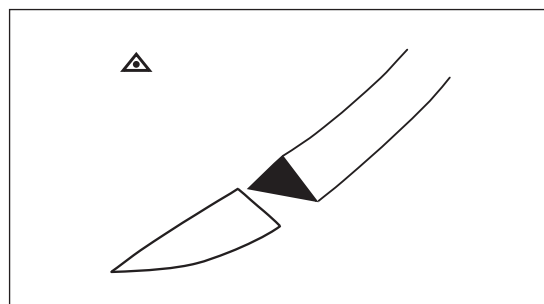

Cutting Needles for Plastic and Cosmetic Surgery

PRIME and PRIME MULTIPASS needles

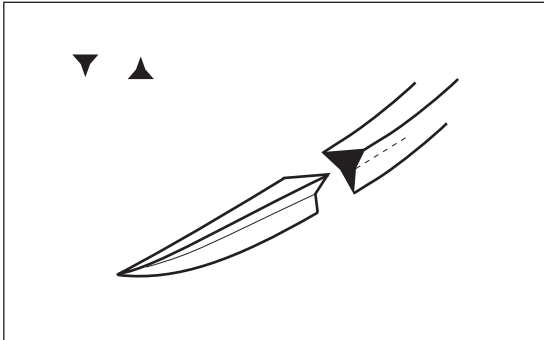

PRIME and PRIME MULTIPASS needles are manufactured with an exclusive needle tip design. The cross sectional geometry of the needle tip reduces the angles of the cutting edges which gives improved penetration and control.

A square body on the needle greatly increases needle strength and offers improved stability in the needle holder. PRIME needles are available with either a reverse cutting or a conventional cutting profile.

PRIME MULTIPASS needles offer PRIME geometry and advanced MULTIPASS needle coating technology.

SUPERIOR EASE OF PENETRATION

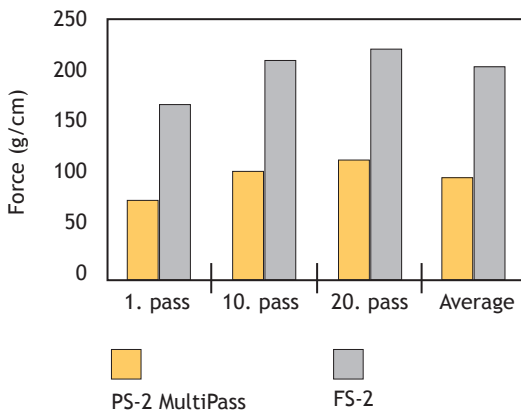

SUPERIOR RESISTANCE TO BENDING

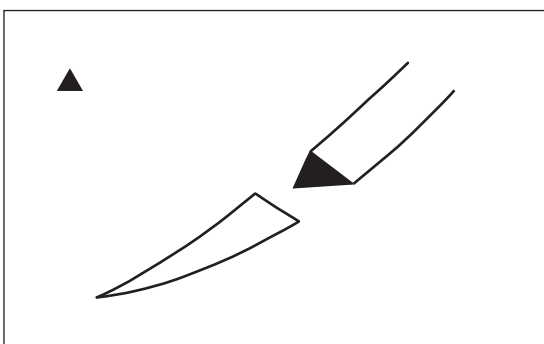
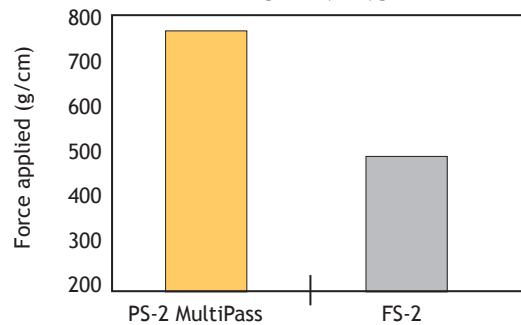

Cutting Needles for Skin Closure

Conventional Cutting Needle

This needle has a triangular cross section with the apex of the triangle on the inside of the needle curvature. The effective cutting edges are restricted to the front section of the needle and merge into a triangulated body which continues for half the length of the needle.

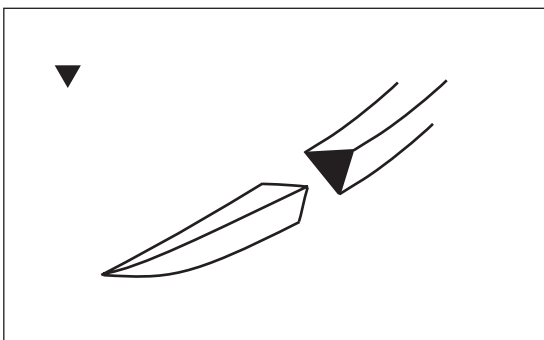

Reverse Cutting Needle

The body of this needle is triangular in cross section, having the apex cutting edge on the outside of the needle curvature. This improves the strength of the needle and particularly increases its resistance to bending.

Ophthalmic Needles

These fine needles are manufactured using a unique process which ensures extremely sharp cutting edges. The range includes spatulated designs for suturing specific layers of the eye in Anterior Segment surgery in addition to round bodied, cutting and TAPERCUT designs for specific ophthalmic and oculoplastic procedures.

CS-ULTIMA Spatula Needle

This needle represents a dramatic change in ophthalmic needle design. Its concave spatula geometry requires considerably less force to penetrate corneal scleral tissue than existing needles. This results in much less disruption of the of the cornea and the real possibility of reduced post-operative suture related astigmatism.

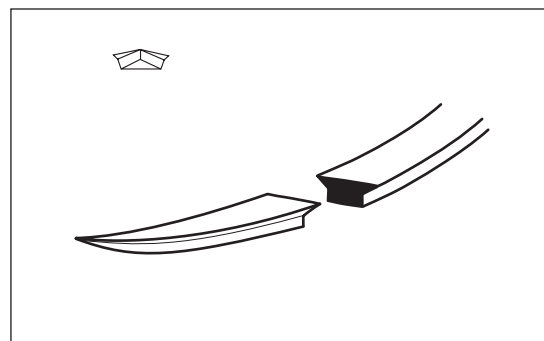

ADVANCED MICRO-POINT Spatula Needle

Due to the ultra fine diameter of this needle, a new concept of design has been necessary. An extremely sharp cutting point has been merged into a square body to produce superb penetration characteristics. In addition, the square body greatly increases resistance to bending and gives much improved needle holder security, locking the needle at the correct angle for secure accurate suture placement.

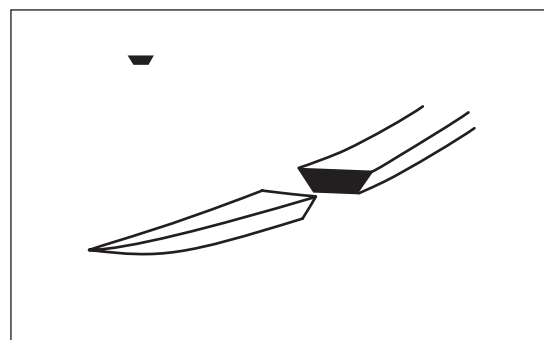

MICRO-POINT Spatula Needle

This needle has a thin, flat profile which allows the needle to penetrate between the layers of scleral or corneal tissue.

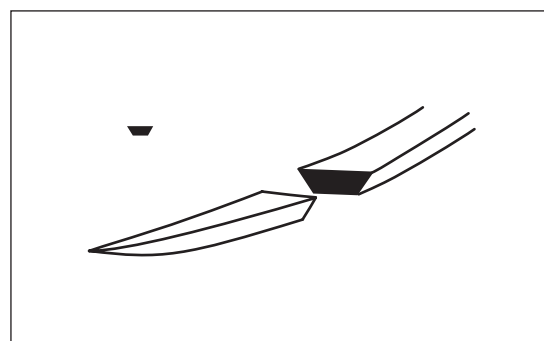

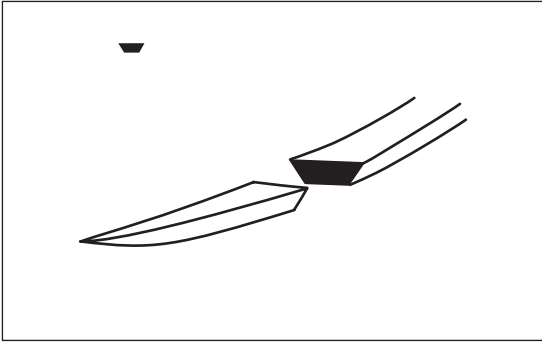

SPATULATED Needle

Similar in cross section to MICRO-POINT Spatula needles, this is designed for scleral suturing which requires stronger needles and where the elimination of cut out or cut down by a third edge is essential.

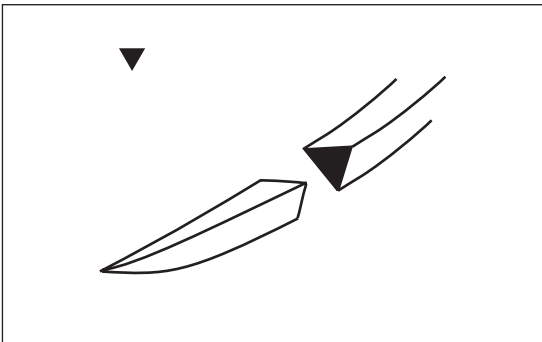

MICRO-POINT Reverse Cutting Needle

The third cutting edge of this needle lies on the outside of its curvature, thereby eliminating the possibility of needle cut out during suture placement.

CONTROL RELEASE Needle Sutures

1. The needle is held securely in the needle holder. Suture is grasped securely just below needle, pulling strand taut.

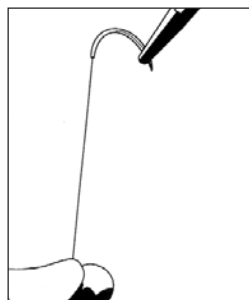

2. The needle is released with a straight tug of the needleholder.

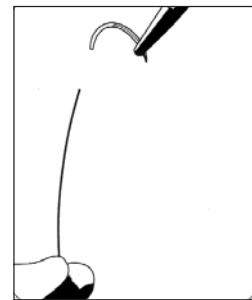

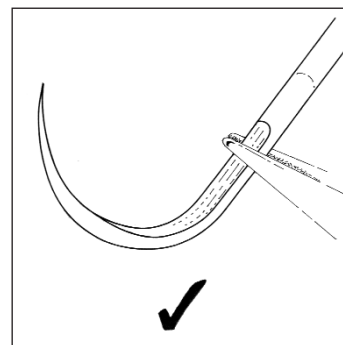
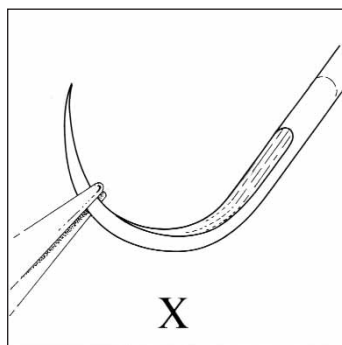
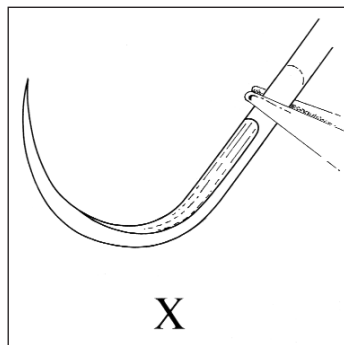













Use of Needle Holders

- 1 The needle holder should be carefully selected to match the size and strength of the needle to be used. The use of a needle holder larger than required can result in damage to the needle and in particular, distortion of the curvature.
- 2 The needle holder should be in good condition as worn jaws can result in needle rotation and instability in the needle holder. Nicks or defects in the needle holder jaws can also cause damage to the needle and loss of strength.
- 3 Needles should be grasped securely on the tip of the needle holder jaws.
- 4 Needles should only be held in the flattened area provided and should not be grasped on the attachment area or near to the needle point. Needles which are not flattened should be grasped for placement at a point approximately one third of the needle length from the butt. Excessive force should not be applied when gripping the needle, particularly with Tungsten Carbide jaw inserts, as this may damage the needle body and cause loss of strength or breakage.

Use of Surgical Needles

- 1 The force required to achieve passage of the needle through tissue should be applied in a direction following the curvature of the needle.
- 2 Care should be taken to match the size of the needle to the size of tissue bite required. The use of too small a needle for a given tissue bite can lead to bending.
- 3 Should the placement of the needle in tissue require to be readjusted, the needle should be removed and re-inserted. No attempt should be made to twist the needle in tissue.
- 4 The needles should normally be inserted separately into each side of the tissue to be approximated and should not be used to bridge a wound.

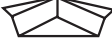
Needle Point Profiles

Needle Profile	New Graphic
Taper Point (Round Bodied)	
Taper Point Plus (modified point)	
ETHIGUARD Blunt Point Needle	
Blunt Point	
TAPERCUT Needle	
CC Needle	
TROCAR Point	
Conventional Cutting	
Reverse Cutting	
PRIME Needle Conventional Cutting	
PRIME Needle Reverse Cutting	
CS ULTIMA Spatula Needle	
Spatula	

Plus Antibacterial Sutures

ETHICON developed VICRYL* Plus, MONOCRYL* Plus and PDS* Plus Antibacterial Sutures in order to address the problem of Surgical Site Infections (SSIs).

ETHICON Plus Sutures contain IRGACARE* MP (triclosan), an antibacterial technology that helps inhibit bacterial colonization on the surface of the suture ¹.

Since 66% of infections are confined to the incision, use Plus Sutures as part of your SSI protocol to help prevent them ².

SUTURES
Plus
Antibacterial
Suture



IRGACARE* MP - The Antibacterial Component

ETHICON Plus Sutures, with IRGACARE* MP, provide the same wound healing, wound strength and tissue response as traditional sutures ³.

IRGACARE* MP, the purest form of triclosan, has a favorable safety profile spanning over 30 years ⁴. The safety of triclosan as the antibacterial agent in Plus Sutures has been well evaluated and confirmed. Over 150 million Plus Sutures have been distributed.

Triclosan is broken down and metabolized in the body. Triclosan is excreted in a neutralized, inactive form via the kidneys, posing no threat to the patient or the environment ⁴.

VICRYL* Plus, MONOCRYL* Plus and PDS* Plus Sutures with IRGACARE* MP are effective against the pathogens most commonly associated with SSIs ⁵:

- *Staphylococcus aureus*
- *Staphylococcus epidermidis*
- Methicillin-resistant *Staphylococcus aureus* (MRSA)
- Methicillin-resistant *Staphylococcus epidermidis* (MRSE)

MONOCRYL* Plus and PDS* Plus Sutures are also effective against:

- *Escherichia coli*
- *Klebsiella pneumoniae*



VICRYL Plus and another suture
in *Staphylococcus aureus*

References:

- (1) Storch ML, Rothenburger SJ, Jacinto G. Experimental efficacy study of coated VICRYL* Plus antibacterial suture in guinea pigs challenged with *Staphylococcus aureus*. *Surg Infect.* 2004;5:281-288.
- (2) Mangram AJ, Horan TC, Pearson ML, Silver LC, Jarvis WR; The Hospital Infection Control Practices Advisory Committee. Guideline for prevention of surgical infection, 1999. *Am J Infect Control.* 1999;27:97-134.
- (3) Storch M, Scalzo H, Van Lue S, Jacinto G. Physical and functional comparison of Coated VICRYL* Plus Antibacterial suture (coated polyglactin 910 suture with triclosan) with Coated VICRYL* suture (coated polyglactin 910 suture). *Surg Infect.* 2002;3(suppl 1):S89-S98.
- (4) Barbolt TA. Chemistry and safety of Triclosan, and its use as an antibacterial coating on VICRYL* Plus Antibacterial suture (coated polyglactin 910 with Triclosan). *Surg Infect.* 2002;3 (suppl 1):S45-S54.
- (5) Edmiston CE, Seabrook GR, Goheen MP, et al. Bacterial adherence to surgical sutures: Can antibacterial-coated sutures reduce the risk of microbial contamination? *J Am Coll Surg.* 2006;203:481-489.

	ABSORBABLE SUTURES	PHYSICAL CHARACTERISTICS	COLOR	REMAINING TENSILE STRENGTH (% of the original strength)					ABSORPTION RATE	KNOT TYING
				1 w.	2 w.	3 w.	4 w.	6 w.		
ABSORBABLE SUTURES	VICRYL® Rapide Polyglactin 910	Multifilament, coated	Violet Undyed	50% (5 days)	0% (10-14 days)				42 days	1=1=1=1
	MONOCRYL® Polyglactone 25	Monofilament	Violet Undyed	60% 50%	30% 20%			90 - 120 days	1=1=1=1**	
	MONOCRYL® Plus Antibacterial Polyglactone 25									
	VICRYL® (6-0 and larger*) Polyglactin 910	Multifilament, coated	Violet / Undyed		75 %	50 %	25 %	56 - 70 days	2=1=1 / 1=1=1=1	
	VICRYL® Plus Antibacterial Polyglactin 910									
	PDS®II (3-0 and larger*) Polydioxanone	Monofilament	Violet / Undyed		80 %		70 %	60 %	182 -238 days	1=1=1=1**
	PDS® Plus Antibacterial									
	NON-ABSORBABLE SUTURES	PHYSICAL CHARACTERISTICS	COLOR						KNOT TYING	
NON-ABSORBABLE SUTURES	PROLENE® Polypropylene	Monofilament	Blue / Undyed						1=1=1=1/ 2=1=1**	
	PRONOVA® Poly(hexafluoropropylene-VDF)	Monofilament	Blue						1=1=1=1/ 2=1=1**	
	ETHIBOND® Polyester	Multifilament, coated	Green / White						2=1=1 / 1=1=1=1*	
	MERSILENE® Polyester	Multifilament	Green / White						2=1=1	
	ETHILON® Polyamide	Monofilament	Black / Blue						1=1=1=1/ 2=1=1**	
	NUROLON® Polyamide	Multifilament, coated	Black						2=1=1	
	SILK	Multifilament	Black/White/Blue						1=1=1=1	
	STEEL	Monofilament / Multifilament	Undyed						1=1=1=1	

* = Check the catalog for information on thinner sizes

** = Additional throws may be particularly appropriate when knotting any monofilament material

VICRYL* Rapide

(Polyglactin 910) Suture



ETHICON
PART OF THE *Johnson & Johnson* FAMILY OF COMPANIES

VICRYL* Rapide (Polyglactin 910)

SUTURE

Description:	Braided Coated	For easy handling and secure knot tying. For smooth passage through tissue and easy knot tie down.
	Synthetic Absorbable	For minimal tissue reaction. By hydrolysis. Essentially complete in 42 days.

Tensile strength:	Post implantation	Approximate % original strength remaining
	5 days 10-14 days	50% 0%

VICRYL* Rapide suture typically falls off 7-10 days post-operative or can be wiped off subsequently with gauze. Normally the removal of the suture is not required.

Color: Undyed or violet.

Range: 8-0 to 1 (USP). Supplied as needled sutures and ligatures.



Indications: VICRYL* Rapide is intended for use in soft tissue approximation where only short term wound support is required and where the rapid absorption of the suture would be beneficial. Typical areas of use include:

- Skin closure, cuticular or subcuticular
- Episiotomies
- Closure of oral mucosa
- Conjunctival sutures in ophthalmic surgery

Full details in the Instruction for Use included in every package.

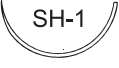
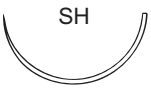

1/2 Circle Taper Point Needles						
Needle	Gauge	Suture Color	Length (cm)	Other information	Number per box	Code
 RB-1 17 mm	5-0	○	70		36	V2130H
	4-0	○	70		36	V2140H
	3-0	○	70		36	V2150H
 SH-1 22 mm	4-0	○	70		36	V2180H
	3-0	○	70		36	V2190H
	2-0	○	70		36	V62H
 SH 26 mm	4-0	○	70		36	V4150H
	3-0	○	70		36	V4160H
	2-0	○	70		36	V4170H

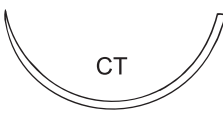
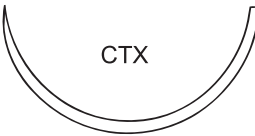



1/2 Circle Taper Point Needles (Heavier Wire Diameter)						
Needle	Gauge	Suture Color	Length (cm)	Other information	Number per box	Code
 CT-2 26 mm	2-0	○	70		36	V55H
 CT-1 36 mm	2-0	○	90		36	V9450H
	0	○	90		36	V9460H
	1	○	90		36	V70H
 CT 40 mm	0	○	90		36	V9580H
 CTX 48 mm	0	○	90		36	PN1695H

1/2 Circle ETHIGUARD* Blunt Point Needles						
Needle	Gauge	Suture Color	Length (cm)	Other information	Number per box	Code
 CTB-1 36 mm	2-0	○	90		36	W9952H

Straight Taper Point Needles						
Needle	Gauge	Suture Color	Length (cm)	Other information	Number per box	Code
 ST-4 19 mm	4-0	○	70		36	BA1673H

VICRYL* Rapide (Polyglactin 910)



1/2 Circle TAPERCUT* Needles

Needle	Gauge	Suture Color	Length (cm)	Other information	Number per box	Code
 V-5 17 mm	3-0	○	70		12	OA1674G
 V-7 26 mm	3-0	○	70		12	OB1674G
	3-0	○	70		36	OB1674H
 V-34 36 mm	2-0	○	90		36	V5170H
	0	○	90		36	V5180H
 V-39 45 mm	2-0	○	90		12	W9945

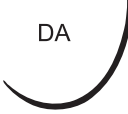



Compound Curve TAPERCUT* Needles





Needle	Gauge	Suture Color	Length (cm)	Other information	Number per box	Code
 DA 16 mm	4-0	○	45		12	V2912G



1/2 Circle Reverse Cutting PRIME* Needles

Needle	Gauge	Suture Color	Length (cm)	Other information	Number per box	Code
 P-2 8 mm	4-0	○	45		36	JA1642H
 PS-4C 16 mm	4-0	○	45		12	W9911

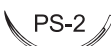

1/2 Circle Reverse Cutting Needles

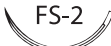
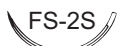
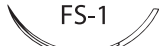
Needle	Gauge	Suture Color	Length (cm)	Other information	Number per box	Code
 J-1 17 mm	4-0	○	45		12	18510G
	4-0	○	45		36	V4550H
	3-0	○	45		36	V76H
 X-1 22 mm	3-0	○	45		36	V7902H
	2-0	○	45		36	V81H
 CP-1 36 mm	2-0	○	90		36	V4721H
 CP 40 mm	0	○	90		36	V4851H
	1	○	90		36	V4861H

3/8 Circle Reverse Cutting PRIME* Needles						
Needle	Gauge	Suture Color	Length (cm)	Other information	Number per box	Code
 P-1 11 mm	6-0	○	45	MULTIPASS*	36	MPVR9913H
	6-0	●	45		36	V32H
	6-0	○	45		12	W9913
	5-0	○	45	MULTIPASS*	36	MPVR9915H
	5-0	○	45		12	W9915
 P-3 13 mm	5-0	○	45	MULTIPASS*	36	MPVR4930H
	5-0	○	45		36	V4930H
	4-0	○	45	MULTIPASS*	36	MPVR4940H
	4-0	○	45		36	V4940H
 PS-2 19 mm	4-0	○	45	MULTIPASS*	36	MPVR4960H
	4-0	○	75		12	W9922
	4-0	○	75	MULTIPASS*	36	MPVR4260H
	3-0	○	45		36	V4970H
	3-0	○	45	MULTIPASS*	36	MPVR4970H
	3-0	○	70	MULTIPASS*	36	MPVR4270H
	3-0	○	75		12	W9923
 PS-2 S 19 mm	4-0	○	45	Slimmed	36	V4960H
	4-0	○	70	Slimmed	36	V4260H
 PS-1 24 mm	3-0	○	45		36	V6830H
	3-0	○	70	MULTIPASS*	36	MPVR9360H
	3-0	○	70		36	V9360H
	2-0	○	70	MULTIPASS*	36	MPVR9380H
	2-0	○	70		36	V9380H





3/8 Circle Reverse Cutting Needles						
Needle	Gauge	Suture Color	Length (cm)	Other information	Number per box	Code
 C-3 13 mm	5-0	○	75		36	VR2289
 FS-2 19 mm	5-0	○	45		36	V2910H
	4-0	○	45		36	FH1642H
	4-0	○	75		12	W9930
	3-0	○	45		12	V2930G
	3-0	○	45		36	V2930H
 FS-2S 19 mm	4-0	○	45	Slimmed	36	V2920H
 FS-1 24 mm	3-0	○	45		36	V4421H
	3-0	○	70		36	V4420H
	2-0	○	45		36	V4431H
 FS 26 mm	3-0	○	75		12	W9940
	2-0	○	75		12	W9941
 FSL 30 mm	2-0	○	90		36	VR2286

VICRYL* Rapide (Polyglactin 910)

▲ Straight Cutting Needles						
Needle	Gauge	Suture Color	Length (cm)	Other information	Number per box	Code
 TS 48 mm	3-0	○	75		36	VR2239
	2-0	○	75		36	VR2240
 KS 60 mm	3-0	○	70		36	AA1673H

▲ 3/8 Circle Conventional Cutting PRIME* Needles						
Needle	Gauge	Suture Color	Length (cm)	Other information	Number per box	Code
 PC-3 16 mm	4-0	○	70	MULTIPASS*	36	MPVR9918H
	3-0	○	75		12	W9919

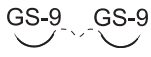
● 3/8 CIRCLE Taper Point needles						
Needle	Gauge	Suture Color	Length (cm)	Other information	Number per box	Code
 BV-1 9,3 mm	8-0	●	30		12	W9916

▼ 3/8 Circle MICROPOINT* Spatula						
Needle	Gauge	Suture Color	Length (cm)	Other information	Number per box	Code
 GS-12 5,5 mm	8-0	●	30		12	V1220G
 GS-9 6,5 mm	8-0	●	30		12	V1210G
	7-0	●	30		12	V1211G
 GS-9 GS-9 6,5 mm	8-0	●	30		12	V39G
	7-0	●	45		12	V38G
 TG140-8 6,5 mm	7-0	●	30		12	W9914

Ligatures						
	Gauge	Suture Color	Length (cm)	Other information	Number per box	Code
	2-0	○	3x45		24	V8645E
	0	○	3x45		24	V8646E
	0	○	6x45		24	V8980E

MONOCRYL*

(Poliglecaprone 25) Suture



ETHICON
PART OF THE *Johnson & Johnson* FAMILY OF COMPANIES

MONOCRYL*

(Poliglecaprone 25) Monofilament

SUTURE

Description: **Monofilament** For smooth passage through tissue.
Synthetic For minimal tissue reaction.
Absorbable By hydrolysis. Essentially complete in 90 -120 days.

Tensile strength: **Post implantation** **Approximate % original**
trength remaining

7 days	60% (violet) 50% (undyed)
14 days	30% (violet) 20% (undyed)
21 days	0% (undyed)
28 days	0% (violet)

Color: Violet or undyed.



























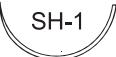











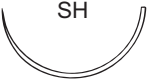











Range: 6-0 to 1 (USP). Supplied as needed sutures and ligatures.

Indications: MONOCRYL* sutures are intended for use in general soft tissue approximation and/or ligation where an absorbable material is indicated. Typical areas of use include:











- Subcuticular sutures
- Small intestine anastomoses
- Urological anastomoses



Full details in the Instruction for Use included in every package.







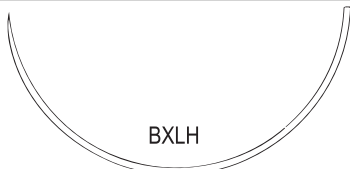









 1/2 Circle Taper Point Needles							
Needle	Gauge	Suture Color	Length (cm)	Other information	Number per box	Code	
 TF 13 mm	6-0		70		36	Y432H	
	5-0		70		36	Y925H	
 RB-1 17 mm	6-0		70		36	Y212H	
	5-0		70		36	Y213H	
	4-0		70		36	Y214H	
	3-0		70		36	T4215AH	
	3-0		70		36	Y215H	
 JRB-1  VISI-BLACK 17 mm	4-0		70	VISI-BLACK*	36	Y3040H	
 JRB-1 JRB-1  VISI-BLACK 17 mm	5-0		70	VISI-BLACK*	36	Y3213H	
	4-0		70	VISI-BLACK*	36	Y3214H	
 SH-1 22 mm	4-0		70		36	Y218H	
	3-0		70		36	Y219H	
 JB-1  VISI-BLACK 22 mm	4-0		70	VISI-BLACK*	36	Y3100H	
	3-0		70	VISI-BLACK*	36	Y3110H	
	2-0		70	VISI-BLACK*	36	Y3120H	
 JB-1 JB-1  VISI-BLACK 22 mm	4-0		70	VISI-BLACK*	36	Y3218H	
	4-0		90	VISI-BLACK*	36	Y5218H	
	3-0		70	VISI-BLACK*	36	Y3219H	
 SH 26 mm	4-0		70		36	Y415H	
	3-0		70		12	NP0001	
	3-0		70		36	Y416H	
	2-0		70		36	Y417H	
	0		70		36	Y418H	
 JB  VISI-BLACK 26 mm	4-0		70	VISI-BLACK*	36	Y3150H	
	3-0		70	VISI-BLACK*	36	Y3160H	
	3-0		8x45	CONTROL RELEASE*, VISI-BLACK*	12	Y3864G	
	3-0		8X70	CONTROL RELEASE*, VISI-BLACK*	12	Y7840G	
	2-0		70	VISI-BLACK*	36	Y3170H	
 JB JB  VISI-BLACK 26 mm	3-0		70	VISI-BLACK*	36	Y3416H	
	3-0		90	VISI-BLACK*	36	Y5270H	
	2-0		70	VISI-BLACK*	36	Y3417H	
 MH-1 31 mm	3-0		70		12	W3200	
	2-0		70		12	W3441	
 MH 36 mm	2-0		70		36	Y227H	

MONOCRYL*
(Poliglecaprone 25) Monofilament

1/2 Circle Taper Point Needles (Heavier Wire Diameter)						
Needle	Gauge	Suture Color	Length (cm)	Other information	Number per box	Code
 CT-2 26 mm	2-0		90		36	Y326H
	0		70		36	Y270H
 CT-1 36 mm	2-0		70		36	Y259H
	0		70		36	Y260H
	0		90		36	Y946H
	1		70		36	Y261H
 CTX 48 mm	2-0		90		12	Y979G
	1		90		12	Y977G

1/2 Circle ETHIGUARD* Blunt Point Needles						
Needle	Gauge	Suture Color	Length (cm)	Other information	Number per box	Code
 BXLH 70 mm	1		90		12	W3709



5/8 Circle Taper Point Needles						
Needle	Gauge	Suture Color	Length (cm)	Other information	Number per box	Code
 UV-17 17 mm	4-0		45	TAPERCUT*	12	NP0128
 UR-6 26 mm	3-0		70		12	W3625
	2-0		70		36	Y605H
 UR-6 26 mm	3-0		70		36	Y602H
 UR-5 36 mm	2-0		70		36	Y375H

1/2 Circle TAPERCUT* Needles						
Needle	Gauge	Suture Color	Length (cm)	Other information	Number per box	Code
 V-7 26 mm	2-0		70		36	Y999H
 V-34 36 mm	2-0		70		12	W3488
	0		70		12	W3489
	1		90		36	Y919H



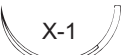

Compound Curve TAPERCUT+ Needles

Needle	Gauge	Suture Color	Length (cm)	Other information	Number per box	Code
 DA-1 13 mm	5-0	○	45		12	Y4950G

1/2 Circle Reverse Cutting Needles

Needle	Gauge	Suture Color	Length (cm)	Other information	Number per box	Code
 X-1 22 mm	2-0	○	70		36	C459
 CP-2 26 mm	2-0	●	70		12	W3230
 CP-1 36 mm	0	●	70		36	C267

3/8 Circle Reverse Cutting PRIME* Needles



Needle	Gauge	Suture Color	Length (cm)	Other information	Number per box	Code
 P-1 11 mm	6-0	○	45	MULTIPASS*	36	MPY489H
	6-0	○	45		36	Y489H
	5-0	○	45	MULTIPASS*	36	MPY490H
 P-3 13 mm	6-0	○	45	MULTIPASS*	36	MPY492H
	6-0	○	45		36	Y492H
	5-0	○	45	MULTIPASS*	36	MPY493H
	5-0	●	45		36	Y491H
	5-0	○	45		36	Y493H
	4-0	○	45	MULTIPASS*	36	MPY494H
	4-0	○	45		36	Y494H
 PS-3 16 mm	5-0	○	45	MULTIPASS*	36	MPY500H
	5-0	○	45		12	W3204
	4-0	○	45	MULTIPASS*	36	MPY501H
	4-0	○	45		12	W3205
 PS-2 19 mm	5-0	○	45	MULTIPASS*	36	MPY495H
	4-0	○	45	MULTIPASS*	36	MPY496H
	4-0	○	45		12	W3206
	4-0	○	70	MULTIPASS*	36	MPY426H
	3-0	○	45	MULTIPASS*	36	MPY497H
	3-0	○	45		12	W3207
	3-0	○	70		36	C427
	3-0	○	70	MULTIPASS*	36	MPY427H
 PS-1 24 mm	4-0	○	45		36	T4682H
	4-0	○	70	MULTIPASS*	36	MPY935H
	4-0	○	70		36	Y495H
	3-0	○	70		12	W3208
	3-0	○	70	MULTIPASS*	36	MPY683H
	2-0	○	70	MULTIPASS*	36	MPY684H
	2-0	○	70		36	Y684H

MONOCRYL*

(Poliglecaprone 25) Monofilament

▼ 3/8 Circle Reverse Cutting PRIME* Needles						
Needle	Gauge	Suture Color	Length (cm)	Other information	Number per box	Code
 26 mm	4-0	○	70	MULTIPASS*	36	MPY3212H
	4-0	○	70		12	W3212
	3-0	○	70	MULTIPASS*	36	MPY3213H
	3-0	○	70		12	W3213

▼ Compound Curve Reverse Cutting PRIME* Needles						
Needle	Gauge	Suture Color	Length (cm)	Other information	Number per box	Code
 16 mm	5-0	○	45		12	NP0127

▼ 3/8 Circle Reverse Cutting Needles						
Needle	Gauge	Suture Color	Length (cm)	Other information	Number per box	Code
 19 mm	4-0	○	45		36	Y292H
	4-0	○	70		36	Y422H
	3-0	○	45		36	Y293H
	3-0	○	70		36	Y423H
 24 mm	4-0	○	70		36	Y291H
	3-0	○	70		36	Y442H
	2-0	○	70		36	Y443H
 26 mm	3-0	○	70		12	W3326

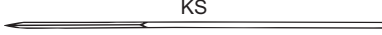
▲ Straight Cutting Needles						
Needle	Gauge	Suture Color	Length (cm)	Other information	Number per box	Code
 48 mm	4-0	○	70		36	C1041
 60 mm	4-0	○	70		12	W3649
	3-0	○	70		12	W3650

▼ 1/4 Circle Spatula Needles						
Needle	Gauge	Suture Color	Length (cm)	Other information	Number per box	Code
 8 mm	6-0	○	45		12	W3552

Ligatures						
	Gauge	Suture Color	Length (cm)	Other information	Number per box	Code
LIGAPAK*	3-0	●	250	Reel	10	W3020
SUTUPAK*	2-0	●	150		12	W3113
	0	●	150		12	W3114
	1	●	150		12	W3115
	2-0	●	2x70		36	Y625H
	3-0	○	3x45		36	Y634H

MONOCRYL* Plus

(Poliglecaprone 25) Antibacterial Suture



ETHICON
PART OF THE *Johnson & Johnson* FAMILY OF COMPANIES

MONOCRYL* Plus

(Poliglecaprone 25) Antibacterial

SUTURE

Description: **Monofilament** For smooth passage through tissue.
Synthetic For minimal tissue reaction.
Absorbable By hydrolysis. Essentially complete in 90 -120 days.

Tensile strength: **Post implantation** **Approximate % original trength remaining**

7 days	60% (violet) 50% (undyed)
14 days	30% (violet) 20% (undyed)
21 days	0% (undyed)
28 days	0% (violet)

Color: Violet or undyed.

Range: 6-0 to 1 (USP). Supplied as needled sutures and ligatures.

Indications: MONOCRYL* Plus sutures are intended for use in general soft tissue approximation and/or ligation where absorbable material is indicated. Typical areas of use include:























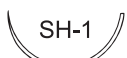











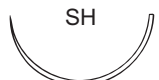





- Subcuticular sutures
- Small intestine anastomoses
- Urological anastomoses

Protection against bacterial colonization

In vitro studies demonstrate, that MONOCRYL* Plus suture has a zone of inhibition that is effective against the pathogens that most frequently cause surgical site infection, including *Staphylococcus aureus*, methicillin resistant *Staphylococcus aureus* (MRSA), *Staphylococcus epidermidis*, methicillin resistant *Staphylococcus epidermidis* (MRSE), *E. coli* and *Klebsiella pneumoniae*.

Full details in the Instruction for Use included in every package.

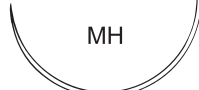







 1/2 Circle Taper Point Needles						
Needle	Gauge	Suture Color	Length (cm)	Other information	Number per box	Code
 TF 13 mm	6-0		70		36	MCP432H
	5-0		70		36	MCP925H
 RB-1 17 mm	6-0		70		36	MCP212H
	5-0		70		36	MCP2131H
	4-0		70		12	MCP3435G
	3-0		70		36	MCP215H
 JRB-1 JRB-1  VISI-BLACK 17 mm	4-0		90	VISI-BLACK*	36	MCP3070H
 SH-1 22 mm	4-0		70		36	MCP218H
	3-0		70		12	MCP219G
 JB-1  VISI-BLACK 22 mm	4-0		70	VISI-BLACK*	36	MCP3100H
	3-0		70	VISI-BLACK*	36	MCP3110H
	2-0		70	VISI-BLACK*	36	MCP3120H
 JB-1 JB-1  VISI-BLACK 22 mm	4-0		70	VISI-BLACK*	36	MCP3218H
	4-0		90	VISI-BLACK*	36	MCP5218H
	3-0		70	VISI-BLACK*	36	MCP3219H
 SH 26 mm	4-0		70		36	MCP4150H
	3-0		70		36	MCP4160H
	2-0		70		36	MCP4170H
 JB  VISI-BLACK 26 mm	4-0		70	VISI-BLACK*	36	MCP3150H
	3-0		70	VISI-BLACK*	36	MCP3160H
	2-0		70	VISI-BLACK*	36	MCP3170H
 JB JB  VISI-BLACK 26 mm	3-0		70	VISI-BLACK*	36	MCP3416H
	3-0		90	VISI-BLACK*	36	MCP5270H
 MH-1 31 mm	3-0		70		36	MCP3200H
 MH 36 mm	2-0		70		36	MCP227H



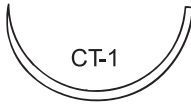

MONOCRYL* Plus

(Poliglecaprone 25) Antibacterial



1/2 Circle Taper Point Needles (Heavier Wire Diameter)

Needle	Gauge	Suture Color	Length (cm)	Other information	Number per box	Code
 CT-2 26 mm	2-0		70		36	MCP4269H
	0		70		36	MCP4270H
 CT-1 36 mm	2-0		70		36	MCP4259H
	0		70		36	MCP260H
	0		90		36	MCP4946H

























5/8 Circle Taper Point Needles



Needle	Gauge	Suture Color	Length (cm)	Other information	Number per box	Code
 UR-6 26 mm	3-0		70		36	MCP3625H
	2-0		70		36	MCP6050H

Compound Curve TAPERCUT* Needles

Needle	Gauge	Suture Color	Length (cm)	Other information	Number per box	Code
 DA-1 13 mm	5-0		45		12	MCP4950G

3/8 Circle Reverse Cutting PRIME* Needles

Needle	Gauge	Suture Color	Length (cm)	Other information	Number per box	Code
 P-1 11 mm	6-0		70	MULTIPASS*	36	MCP489H
	5-0		70	MULTIPASS*	36	MCP490H
 P-3 13 mm	6-0		70	MULTIPASS*	36	MCP492H
	5-0		70	MULTIPASS*	36	MCP493H
	4-0		70	MULTIPASS*	36	MCP494H
 PS-3 16 mm	5-0		70	MULTIPASS*	36	MCP500H
	4-0		70	MULTIPASS*	12	MCP3205G
 PS-2 19 mm	5-0		70	MULTIPASS*	36	MCP495H
	4-0		45	MULTIPASS*	36	MCP496H
	4-0		70	MULTIPASS*	36	MCP4260H
	4-0		70	MULTIPASS*	36	MCP498H
	3-0		45	MULTIPASS*	36	MCP497H
	3-0		70	MULTIPASS*	36	MCP428H
	3-0		70	MULTIPASS*	36	MCP4271H
 PS-1 24 mm	4-0		70	MULTIPASS*	36	MCP9350H
	3-0		70	MULTIPASS*	36	MCP683H
	2-0		70	MULTIPASS*	36	MCP684H
 PS 26 mm	3-0		70	MULTIPASS*	36	MCP3213H

▼ 3/8 Circle Reverse Cutting Needles						
Needle	Gauge	Suture Color	Length (cm)	Other information	Number per box	Code
 FS-2	19 mm	5-0	○	70	12	MCP3209G
		4-0	○	45	36	MCP292H
		4-0	○	70	36	MCP4422H
		3-0	○	45	36	MCP293H
		3-0	○	70	36	MCP4423H
 FS-1	24 mm	4-0	○	70	36	MCP291H
		3-0	○	70	36	MCP442H
		2-0	○	70	36	MCP4443H
 FS	26 mm	3-0	○	70	12	MCP3326G

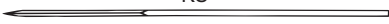
▲ Straight Cutting Needles						
Needle	Gauge	Suture Color	Length (cm)	Other information	Number per box	Code
 KS	60 mm	4-0	○	70	12	MCP3649G
		3-0	○	70	12	MCP3650G



VICRYL*

(Polyglactin 910) Suture



ETHICON
PART OF THE *Johnson & Johnson* FAMILY OF COMPANIES

VICRYL*
(Polyglactin 910) Braided and Monofilament

SUTURE

Description:	Braided Coated	For easy handling and secure knot tying. For smooth passage through tissue and easy knot tie down.
	Synthetic Absorbable	For minimal tissue reaction. By hydrolysis. Essentially complete in 56-70 days.

Tensile strength:	Post implantation	Approximate % original strength remaining
	14 days	75%
	21 days	50% (6-0 and larger) 40% (7-0 and smaller)
	28 days	25% (6-0 and larger)

Color: Violet or undyed.













Range: 10-0 to 6 (USP). Supplied as needled sutures and ligatures. Sizes 10-0 and 9-0 are monofilament in structure.

Indications: VICRYL* sutures are intended for use in soft tissue approximation and/or ligation, including use in ophthalmic surgery, peripheral nerve adaptation and microsurgery for vessels less than 2 mm in diameter. Typical areas of use include:

- Fascia closure - due to the 28-day claim
- Subcutaneous fat
- Joint capsule
- Uterus





Full details in the Instruction for Use included in every package.





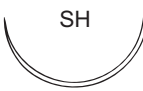

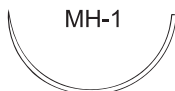

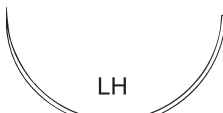
 1/2 Circle Taper Point Needles							
Needle		Gauge	Color	Length (cm)	Other information	Number per box	Code
 TF-6 6,5 mm		8-0	●	30		12	V1027G
		7-0	●	30		36	V1028H
 TF-1 10 mm		5-0	●	70		36	V133H
 RB-2 13 mm		6-0	●	70		36	PZ2571H
		6-0	○	45		12	W9981
 TF 13 mm		6-0	●	70		36	V926H
		5-0	●	70		36	V925H
		4-0	●	70		36	V924H
 RB-1 17 mm		6-0	●	70		36	V302H
		5-0	●	70		36	V303H
		5-0	○	70		36	V213H
		4-0	●	70		36	V304H
		4-0	○	70		36	V214H
		4-0	●	8x45	CONTROL RELEASE*	24	V734E
		4-0	●	4x45	CONTROL RELEASE*	12	V735G
		4-0	●	8x70	CONTROL RELEASE*	24	V799E
		3-0	●	70		36	V305H
		3-0	○	70		36	V215H
		3-0	●	8x45	CONTROL RELEASE*	12	J713D
		2-0	●	70		36	V306H
 RB-1 RB-1 17 mm		3-0	●	70		36	V667H
 JRB-1  VISI-BLACK 17 mm		5-0	●	70	VISI-BLACK*	36	V3030H
		4-0	●	70	VISI-BLACK*	36	V3040H
 SH-1 22 mm		4-0	●	70		36	V310H
		4-0	○	70		36	V426H
		3-0	●	70		36	V311H
		3-0	○	70		36	V219H
		3-0	●	4x45	CONTROL RELEASE*	36	V782H
		2-0	●	70		36	V312H
		2-0	○	70		36	V220H
		2-0	●	8x45	CONTROL RELEASE*	24	V792E
 JB-1  VISI-BLACK 22 mm		4-0	●	70	VISI-BLACK*	36	V3100H
		3-0	●	70	VISI-BLACK*	36	V3110H
		2-0	●	70	VISI-BLACK*	36	V3120H

VICRYL*



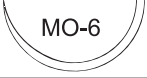
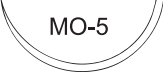

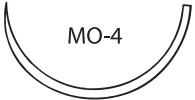
(Polyglactin 910) Braided and Monofilament

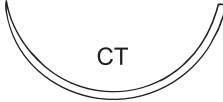

 1/2 Circle Taper Point Needles						
Needle	Gauge	Color	Length (cm)	Other information	Number per box	Code
 SH 26 mm	4-0	●	70		36	V315H
	4-0	●	8x70	CONTROL RELEASE*	12	V783G
	3-0	●	70		36	V316H
	3-0	○	70		36	V416H
	3-0	●	90		36	V242H
	3-0	●	8x45	CONTROL RELEASE*	12	J774D
	2-0	●	70		36	V317H
	2-0	○	70		36	V224H
	2-0	●	90		36	V243H
	2-0	●	8x45	CONTROL RELEASE*	12	J775D
	0	●	70		36	V318H
	0	○	70		36	V225H
	 JB VISI-BLACK 26 mm	4-0	●	70	VISI-BLACK*	36
3-0		●	70	VISI-BLACK*	36	V3160H
3-0		○	70	VISI-BLACK*	36	V4416H
3-0		●	8x45	CONTROL RELEASE*	24	V7740E
3-0		●	8x70	CONTROL RELEASE*	24	V7840E
2-0		●	70	VISI-BLACK*	36	V3170H
 MH-1 31 mm	3-0	●	70		36	V245H
	2-0	●	70		36	V246H
	0	●	70		36	V247H
 MH 36 mm	4-0	●	90		36	PG2592H
	3-0	●	70		36	V322H
	3-0	●	90		36	V100H
	2-0	●	70		36	V323H
	2-0	○	70		36	V226H
	2-0	●	90		36	V101H
	0	●	70		36	V324H
	0	●	90		36	V102H
	1	●	70		36	V325H
	1	○	70		36	V228H
 LH 40 mm	2-0	●	70		36	PH2574H

 1/2 Circle Taper Point Needles (Heavier Wire Diameter)							
Needle	Gauge	Color	Length (cm)	Other information	Number per box	Code	
 UCL 13 mm	3-0	●	70		36	V113H	
	0	●	70		36	V115H	
 UCLX 16 mm	3-0	●	70		36	V13H	
	2-0	●	70		36	V14H	
	0	●	70		36	V15H	
	1	●	70		36	V16H	
 CT-3 22 mm	3-0	●	70		36	V327H	
	2-0	●	70		36	V328H	
	0	●	70		36	V329H	
 CT-2 26 mm	3-0	●	70		36	V332H	
	2-0	●	70		36	V333H	
	2-0	○	70		36	V269H	
	2-0	●	4x45	CONTROL RELEASE*	24	V7642E	
	0	●	70		36	V334H	
	0	○	70		36	V270H	
	0	●	8x45	CONTROL RELEASE*	24	V744E	
	0	●	4x70	CONTROL RELEASE*	24	4PK2575YE	
	1	●	70		36	V335H	
2	●	70		36	V336H		
 MO-6 27 mm	1	●	90		36	V237H	
 MO-5 31 mm	0	●	75		12	W9215	
	1	●	75		12	W9216	
 CT-1 36 mm	3-0	●	70		36	V338H	
	3-0	○	90		36	V944H	
	2-0	●	70		36	V339H	
	2-0	●	90		36	V345H	
	2-0	○	90		36	V945H	
	2-0	○	8x70	CONTROL RELEASE*	12	JJ42D	
	0	●	70		36	V340H	
	0	●	90		36	V346H	
	0	○	90		36	V946H	
	0	●	8x45	CONTROL RELEASE*	12	J740D	
	1	●	70		36	V341H	
	1	●	90		36	V347H	
	1	●	4x70	CONTROL RELEASE*	12	V736G	
	2	●	90		36	V348H	
2	○	90		36	V948H		
 MO-4 36 mm	0	●	70		36	V436H	
	1	●	90		36	V255H	

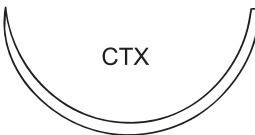

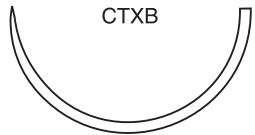

VICRYL*

(Polyglactin 910) Braided and Monofilament

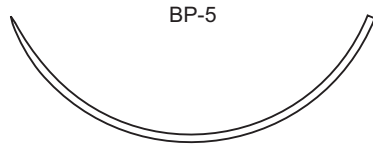
 1/2 Circle Taper Point Needles (Heavier Wire Diameter)						
Needle	Gauge	Color	Length (cm)	Other information	Number per box	Code
 CT 40 mm	3-0	●	70		36	V350H
	2-0	●	70		36	V351H
	2-0	●	8x45	CONTROL RELEASE*	12	8PM2544YG
	0	●	70		36	V352H
	0	●	90		36	V358H
	1	●	70		36	V353H
	1	●	90		36	V359H
	1	●	8x45	CONTROL RELEASE*	12	J753D
	2	●	90		36	V360H
	2	○	90		36	V960H
 MO-45 45 mm	1	●	75		12	W9245
 CTX 48 mm	3-0	●	70		36	V362H
	2-0	●	70		36	V363H
	0	●	70		36	V364H
	0	●	90		36	V370H
	0	○	90		36	V170H
	0	●	8x45	CONTROL RELEASE*	12	J764D
	1	●	70		36	V365H
	1	●	90		36	V371H
	1	○	90		36	V366H
	1	●	8x45	CONTROL RELEASE*	12	J765D
	2	●	90		36	V372H
	2	○	90		36	V367H
 TP-1 65 mm	2	●	90		12	V585G
	2	●	4x70		6	J649
 XLH 70 mm	2-0	●	70		12	V581G
	0	●	70		12	V582G
	1	●	70		12	V583G



1/2 Circle ETHIGUARD* Blunt Point Needles							
Needle	Gauge	Color	Length (cm)	Other information	Number per box	Code	
 MHB-1 31 mm	3-0	●	75		12	W9983	
	2-0	●	75		12	W9984	
 CTB-1 36 mm	2-0	●	75		12	W9985	
	2-0	●	75	Heavy Needle	12	W9993	
	0	●	75		12	W9986	
	0	●	90	Heavy Needle	12	W9994	
	1	●	90	Heavy Needle	12	W9995	
 CTB 40 mm	0	●	75		12	W9988	
	0	●	90	Heavy Needle	12	W9996	
	1	●	90	Heavy Needle	12	W9997	
 CTXB 48 mm	0	●	90		12	W9990	
	1	●	90		12	W9991	



3/8 Circle Blunt Point Needles							
Needle	Gauge	Color	Length (cm)	Other information	Number per box	Code	
 BP-5 65 mm	1	●	100		12	W9391	



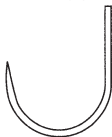

5/8 Circle Taper Point Needles							
Needle	Gauge	Color	Length (cm)	Other information	Number per box	Code	
 UR-6 26 mm	3-0	●	70		36	V601H	
	2-0	●	70		36	V602H	
	0	●	70		36	V603H	
	1	●	70		36	VC2575H	
 UR-6 26 mm	2-0	●	70		36	VCC2573H	
 UR-5 36 mm	2-0	●	70		36	V375H	
	0	●	70		36	V376H	
	1	●	70		36	V377H	
 UR-4 40 mm	2-0	●	70		36	V380H	
	0	●	70		36	V381H	



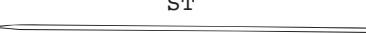

VICRYL*



(Polyglactin 910) Braided and Monofilament



Fish Hook Needles						
Needle	Gauge	Color	Length (cm)	Other information	Number per box	Code
 PB-30 30 mm	2-0	●	70	Taper point	36	DF2570H
	1	●	70	Taper point	36	DF2573H
 V-38 31 mm	1	●	75	TAPERCUT*	12	W9335

Straight Taper Point Needles						
Needle	Gauge	Color	Length (cm)	Other information	Number per box	Code
 ST-4 19 mm	4-0	●	70		36	BA2573H
	3-0	●	70		36	BA2574H
 ST-4 19 mm	4-0	●	35		36	V620H
 ST 48 mm	3-0	●	70		36	BC2573H

1/2 Circle TAPERCUT* Needles						
Needle	Gauge	Color	Length (cm)	Other information	Number per box	Code
 V-5 17 mm	4-0	●	70		12	V994G
	4-0	●	70		36	V994H
	4-0	○	70		36	V230H
	3-0	●	70		36	V276H
 V-6 22 mm	4-0	○	70		36	V231H
 V-7 26 mm	3-0	●	70		12	V998G
	3-0	●	70		36	V998H
	2-0	●	70		36	V999H
	2-0	●	6x45	CONTROL RELEASE*	24	6OB2545YE
	0	●	70		36	V279H
 V-30 31 mm	2-0	●	75		12	W9360
	0	●	75		12	W9361
	1	●	75		12	W9362
 V-34 36 mm	3-0	●	90		36	V516H
	2-0	●	90		36	V517H
	0	●	90		36	V518H
	1	●	90		36	V519H

1/2 Circle TAPERCUT* Needles						
Needle	Gauge	Color	Length (cm)	Other information	Number per box	Code
 V-37 40 mm	2-0	○	75	Slimmed	12	W9900
	2-0	○	75		12	W9904
	2-0	●	90		12	W9466
	0	●	90		36	VS4000H
 V-39 45 mm	1	●	75		12	W9377
 V-40 48 mm	2-0	●	90		36	VS5020H
	0	●	70		36	VS5000H
	1	●	150	LOOP	24	V829E
 BPT-1 48 mm	6	●	75		12	V140G
	6	●	150		12	OH2528G







3/8 Circle TAPERCUT* Needles						
Needle	Gauge	Color	Length (cm)	Other information	Number per box	Code
 V-18 13 mm	6-0	●	70		36	V991H
	5-0	●	70		36	V990H
 V-4 17 mm	5-0	○	75		12	W9824
	4-0	○	70		12	V240G
	3-0	○	75		12	W9826

5/8 Circle TAPERCUT* Needles						
Needle	Gauge	Color	Length (cm)	Other information	Number per box	Code
 UV-10 10 mm	6-0	●	30		12	W9172
 UV-17 17 mm	4-0	○	75		12	W9820









Compound Curve TAPERCUT* Needles						
Needle	Gauge	Color	Length (cm)	Other information	Number per box	Code
 DA 25 mm VISI-BLACK	4-0	●	45	VISI-BLACK*	12	18531G



VICRYL*

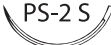



(Polyglactin 910) Braided and Monofilament





▼ 1/2 Circle Reverse Cutting Needles (Heavier Wire Diameter)						
Needle	Gauge	Color	Length (cm)	Other information	Number per box	Code
 X-1 22 mm	3-0	●	70		36	V460H
	3-0	○	70		36	ME2673H
	2-0	●	70		36	V461H
	2-0	○	75		36	JV459
 OS-4 22 mm	0	○	70	HEAVY NEEDLE	36	J694H
	2	●	75	HEAVY NEEDLE	12	W9287
 CP-2 26 mm	3-0	●	70		36	MF2572H
	2-0	●	75		36	JV969
	2-0	○	70		36	V869H
	0	●	70		36	MF2574H
	0	●	4x45	CONTROL RELEASE	24	V870E
	1	○	70		36	MF2675H
 CP-1 36 mm	3-0	●	70		36	V465H
	2-0	●	70		36	V466H
	2-0	●	90		36	V472H
	2-0	○	90		36	JV1472
	0	●	70		36	V467H
	0	●	90		36	V473H
	0	●	4x45	CONTROL RELEASE	12	V475G
	1	●	70		36	V468H
	1	●	90		36	V474H
	2	●	90		36	V482H
 CP 40 mm	2-0	●	70		36	V478H
	0	●	70		36	V479H
	0	●	90		36	V485H
	1	●	70		36	V480H
	1	●	90		36	V486H
 CPX 48 mm	0	●	90		36	V1057H
	1	●	90		36	V1058H
	2	●	90		36	V1059H



▼ 1/2 Circle Reverse Cutting PRIME* Needles						
Needle	Gauge	Color	Length (cm)	Other information	Number per box	Code
 PS-4 16 mm	5-0	○	45	Compound curve	12	W9436
	4-0	○	45		12	V507G
	4-0	○	45	Compound curve	12	W9437



▼ 3/8 Circle Reverse Cutting PRIME* Needles						
Needle	Gauge	Color	Length (cm)	Other information	Number per box	Code
 P-1 11 mm	6-0	○	45	MULTIPASS*	36	MPV489H
	6-0	○	45		36	V489H
	5-0	○	45	MULTIPASS*	36	MPV490H
	5-0	○	45		36	V490H
 P-3 13 mm	6-0	○	45	MULTIPASS*	36	MPV492H
	6-0	○	45		36	V492H
	5-0	○	45	MULTIPASS*	36	MPV493H
	5-0	○	45		36	V493H
	4-0	○	45	MULTIPASS*	36	MPV494H
	4-0	○	45		36	V494H
 PS-3 16 mm	5-0	○	45	MULTIPASS*	36	MPV500H
	4-0	○	45		24	W9506T
 PS-2 19 mm	5-0	○	45	MULTIPASS*	36	MPV495H
	4-0	○	45	MULTIPASS*	36	MPV496H
	4-0	○	45		24	W9515T
	3-0	○	45	MULTIPASS*	36	MPV497H
	3-0	○	45		36	V497H
 PS-2 S 19 mm	4-0	○	45	Slimmed	36	V496H
 PS-1 24 mm	4-0	○	70		36	JE2672H
	3-0	○	45	MULTIPASS*	36	MPV683H
	3-0	○	45		36	V683H
	2-0	○	45	MULTIPASS*	36	MPV684H
	2-0	○	45		36	V684H
 PS 26 mm	3-0	○	70	MULTIPASS*	36	MPV9526H
 PSL 30 mm	2-0	●	70		36	V686H

▼ 3/8 Circle Reverse Cutting Needles						
Needle	Gauge	Color	Length (cm)	Other information	Number per box	Code
 C-3 13 mm	6-0	●	45		36	V384H
	5-0	○	45		36	BV1389
	5-0	●	45		36	V385H
	4-0	●	45		36	V386H
 FS-3 16 mm	6-0	●	45		36	V387H
	5-0	●	45		36	V388H
	4-0	●	75	CONVENTIONAL CUTTING	12	W9443

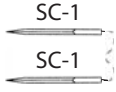
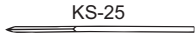

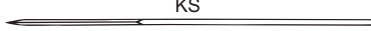
▼ 3/8 Circle Reverse Cutting Needles						
Needle	Gauge	Color	Length (cm)	Other information	Number per box	Code
 FS-2 19 mm	5-0	○	45		36	V291H
	5-0	●	45		36	V391H
	5-0	○	70		36	V421H
	4-0	○	45		36	V292ZH
	4-0	●	45		12	V392ZG
	3-0	○	45		36	V293H
	3-0	●	45		12	V393G
	3-0	●	45		36	V393H
	3-0	○	70		36	V423H
	3-0	●	70		36	V398H
 FS-2S 19 mm	4-0	○	45	Slimmed	36	V292H
	4-0	●	45	Slimmed	36	V392H
	4-0	○	70	Slimmed	36	V422H
	4-0	●	70	Slimmed	36	V397H
 FS-1 24 mm	4-0	○	70		36	V441H
	4-0	●	70		36	V451H
	3-0	○	70		36	V442H
	3-0	●	70		36	V452H
	2-0	○	70		36	V443H
	2-0	●	70		36	V453H
 FSL 30 mm	3-0	○	70		36	V588H
	3-0	●	70		36	V585H
	2-0	○	75		36	JV589
	2-0	●	70		36	V586H
	0	○	70		36	V520H
	0	●	70		36	V587H

▲ 3/8 Circle Conventional Cutting PRIME* Needles						
Needle	Gauge	Color	Length (cm)	Other information	Number per box	Code
 PC-3 16 mm	5-0	○	45		24	W9505T
	4-0	○	45	MULTIPASS*	36	MPV9506H
 PC-5 19 mm	4-0	○	75		24	W9570T
	3-0	○	70	MULTIPASS*	36	MPV9571H
 PC-25 26 mm	4-0	○	70	MULTIPASS*	36	MPV9580H
	4-0	○	75		24	W9580T
	3-0	○	75		24	W9581T
 PCLX 36 mm	3-0	○	75		24	W9531T

▲ Straight Cutting Needles							
Needle	Gauge	Color	Length (cm)	Other information	Number per box	Code	
 SC-1 13 mm	4-0	●	45		36	V383H	
 KS-25 25 mm	3-0	●	70		12	V2530G	
 TS 48 mm	3-0	○	70		36	AB2673H	
 KS 60 mm	4-0	○	70		36	V662H	
	3-0	●	70		36	V523H	
	3-0	○	70		36	V663H	
	2-0	●	70		36	V524H	
	2-0	○	70		36	V664H	

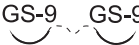

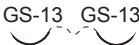
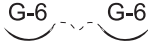
▼ 1/2 Circle MICROPOINT* Spatula							
Needle	Gauge	Color	Length (cm)	Other information	Number per box	Code	
 GS-14 GS-14 5,5 mm	10-0	●	30		12	V450G	
	9-0	●	30		12	V449G	
	8-0	●	20		12	V574G	
 TG175-8 7 mm	7-0	●	45		12	W9565	

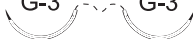

▼ 3/8 Circle MICROPOINT* Spatula							
Needle	Gauge	Color	Length (cm)	Other information	Number per box	Code	
 GS-9 6,5 mm	8-0	●	30		12	V120G	
	7-0	●	30		12	V119G	
 GS-9 GS-9 6,5 mm	10-0	●	30	Monofilament	12	V440G	
	9-0	●	30		12	V549G	
	9-0	●	30	Monofilament	12	V439G	
	8-0	●	20		12	V547G	
	8-0	●	30		12	V548G	
	7-0	●	45		12	V546G	



▼ 3/8 Circle MICROPOINT* Reverse Cutting Needles							
Needle	Gauge	Color	Length (cm)	Other information	Number per box	Code	
 GS-13 GS-13 6,2 mm	10-0	●	30	Monofilament	12	EMM2830G	
 G-6 G-6 8 mm	6-0	●	45		12	W9537	
 G-1 G-1 11 mm	6-0	●	45		12	V554G	
 G-3 G-3 13 mm	5-0	●	45		12	V557G	

VICRYL*





(Polyglactin 910) Braided and Monofilament



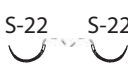

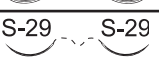

 3/8 Circle CS ULTIMA* Spatula						
Needle	Gauge	Color	Length (cm)	Other information	Number per box	Code
 UCS-35 6,2 mm	10-0	●	15	MONOFILAMENT	12	V429G

 1/8 Circle CS ULTIMA* Spatula						
Needle	Gauge	Color	Length (cm)	Other information	Number per box	Code
 CS44-6 6,5 mm	10-0	●	10	MONOFILAMENT	12	V965

 3/8 Circle Spatula Needles						
Needle	Gauge	Color	Length (cm)	Other information	Number per box	Code
 SPAT-10 11 mm	5-0	○	45		12	W9761

 1/2 Circle Spatula Needles						
Needle	Gauge	Color	Length (cm)	Other information	Number per box	Code
 S-22 S-22 8 mm	6-0	●	45		12	W9566
	6-0	○	45		12	W9756
	5-0	●	45		12	W9567

 1/4 Circle Spatula Needles						
Needle	Gauge	Color	Length (cm)	Other information	Number per box	Code
 S-4 S-4 8 mm	4-0	●	45		12	V572G
 S-29 S-29 8 mm	6-0	●	45	Slim needle	12	V555G
 S-14 S-14 8 mm	6-0	●	45		12	V570G
	6-0	●	45	VISI-BLACK*	12	V575G
	6-0	○	45		12	V670G
	6-0	●	20		12	W9562
	5-0	●	45	VISI-BLACK*	12	V577G
	5-0	●	45		12	V571G
	5-0	○	45		12	V671G

 3/8 Circle Taper Point Needles							
Needle	Gauge	Color	Length (cm)	Other information	Number per box	Code	
BV-6 	4,8 mm	10-0	●	10	Monofilament	12	V970G
BV-4 	4,9 mm	10-0	●	15	Monofilament	12	V971G
BV130-5 	6,5 mm	9-0	●	15	Monofilament	12	V239G
		8-0	●	20		12	V400G
BV-1 	9,3 mm	8-0	●	30		12	W9577
		6-0	●	45		12	V301G
JBB 	17 mm	4-0	●	75	VISI-BLACK*	36	JV2024
		3-0	●	75	VISI-BLACK*	36	JV2025

Ligatures							
	Gauge	Color	Length (cm)	Other information	Number per box	Code	
LIGAPAK*	4-0	●	250	Reel	12	V1204G	
	3-0	●	250	Reel	12	V1205G	
	2-0	●	250	Reel	12	V1206G	
	0	●	250	Reel	12	V1207G	
	1	●	250	Reel	12	V1208G	
	4-0	●	125	Reel	12	V204G	
	3-0	●	125	Reel	12	V205G	
	2-0	●	125	Reel	12	V206G	
	0	●	125	Reel	12	V207G	
SUTUPAK*	3-0	●	140		36	V614H	
	2-0	●	140		36	V615H	
	0	●	140		36	V616H	
	1	●	140		36	V617H	
	2	●	140		36	V618H	
SUTUPAK*	4-0	●	2x70		24	V623E	
	3-0	●	2x70		24	V624E	
	3-0	○	2x70		24	V652E	
	2-0	●	2x70		24	V625E	
	2-0	○	2x70		24	V653E	
	0	●	2x70		24	V626E	
	0	○	2x70		24	V654E	
	1	●	2x70		36	V627H	
	2	●	2x70		36	V628H	

VICRYL*

(Polyglactin 910) Braided and Monofilament

Ligatures						
	Gauge	Color	Length (cm)	Other information	Number per box	Code
SUTUPAK*	5-0	●	3x45		36	V632H
	5-0	○	3x45		36	V642H
	4-0	●	3x45		36	V633H
	4-0	○	3x45		36	V643H
	3-0	●	3x45		36	V634H
	3-0	○	3x45		36	V644H
	2-0	●	3x45		36	V635H
	2-0	○	3x45		36	V645H
	0	●	3x45		24	V636E
	1	●	3x45		24	V637E
	1	○	3x45		24	V647E
	2	●	3x45		36	V638H
SUTUPAK*	4-0	●	5x70		24	V1214E
	3-0	●	5x70		24	V1215E
	2-0	●	5x70		24	V1216E
	0	●	5x70		24	V1217E
	0	○	5x70		24	V965E
	1	●	5x70		36	V1218H
	2	●	5x70		36	V1219H
SUTUPAK*	5-0	●	6x45		36	V1223H
	4-0	●	6x45		36	V1224H
	3-0	●	6x45		36	V1225H
	3-0	○	6x45		36	V978H
	2-0	●	6x45		36	V1226H
	0	●	6x45		24	V1227E
	1	●	6x45		24	V1228E
	2	●	6x45		36	V1229H
SUTUPAK*	4-0	●	12x45		36	V903H
	3-0	●	12x45		36	V904H
	3-0	○	12x45		36	V910H
	2-0	●	12x45		24	V905E
	2-0	○	12x45		24	V911E
	0	●	12x45		24	V906E
	0	○	12x45		24	V912E
	1	●	12x45		24	V907E

VICRYL* Plus

(Polyglactin 910) Antibacterial Suture



ETHICON
PART OF THE *Johnson & Johnson* FAMILY OF COMPANIES

VICRYL* Plus

(Polyglactin 910) Braided Antibacterial

SUTURE

Description:	Braided	For easy handling and secure knot tying.
	Coated	For smooth passage through tissue and easy knot tie down.
	Synthetic	For minimal tissue reaction.
	Absorbable	By hydrolysis. Essentially complete in 56-70 days.

Tensile strength:	Post implantation	Approximate % original strength remaining
	14 days	75%
	21 days	50%
	28 days	25%

Color: Violet or undyed.

Range: 5-0 to 2 (USP). Supplied as needled sutures and ligatures.

Indications: VICRYL* Plus sutures are intended for use in soft tissue approximation and/or ligation, including use in microsurgery for vessels less than 2 mm in diameter. The safety and effectiveness of VICRYL* Plus sutures in cardiovascular tissue, ophthalmic surgery and neurological tissue have not been established. Typical areas of use include:









- Fascia closure - due to the 28-day claim
- Subcutaneous fat
- Joint capsule
- Uterus

Protection against bacterial colonization

In vitro studies demonstrate, that VICRYL* Plus suture has a zone of inhibition that is effective against the pathogens that most frequently cause surgical site infection, including *Staphylococcus aureus*, methicillin resistant *Staphylococcus aureus* (MRSA), *Staphylococcus epidermidis* and methicillin resistant *Staphylococcus epidermidis* (MRSE).

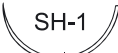
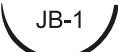
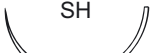
Full details in the Instruction for Use included in every package.

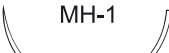











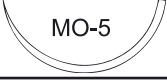

 1/2 Circle Taper Point Needles							
Needle	Gauge	Suture Color	Length (cm)	Other information	Number per box	Code	
 RB-2	13 mm	4-0	○	70		36	VCP434H
 TF	13 mm	5-0	●	70		36	VCP925H
		4-0	●	70		36	VCP924H
 RB-1	17 mm	5-0	●	70		36	VCP303H
		4-0	●	70		36	VCP304H
		4-0	○	70		36	VCP214H
		3-0	●	70		36	VCP305H
		3-0	○	70		36	VCP215H
 SH-1	22 mm	4-0	●	70		36	VCP310H
		4-0	○	70		36	VCPV426H
		4-0	●	8x45	CONTROL RELEASE*	24	VCP794E
		3-0	●	70		36	VCP311H
		3-0	○	70		36	VCP219H
		2-0	●	70		36	VCP312H
		2-0	○	70		36	VCP220H
 JB-1 VISI-BLACK	22 mm	4-0	●	70	VISI-BLACK*	36	VCP3100H
		3-0	●	70	VISI-BLACK*	36	VCP3110H
 SH	26 mm	4-0	●	70		36	VCP315H
		3-0	●	70		36	VCP316H
		3-0	○	70		36	VCP416H
		3-0	●	90		36	VCP242H
		3-0	●	8x70	CONTROL RELEASE*	24	VCP784E
		2-0	●	70		36	VCP317H
		2-0	○	70		36	VCP224H
		2-0	●	90		36	VCP243H
		0	●	70		36	VCP318H
 JB VISI-BLACK	26 mm	3-0	●	70	VISI-BLACK*	36	VCP3160H
		3-0	○	70	VISI-BLACK*	36	VCPV4416H
		3-0	●	8x45	CONTROL RELEASE*	24	VCP7740E
		3-0	●	8x70	CONTROL RELEASE*	24	VCP7840E
		2-0	●	70	VISI-BLACK*	36	VCP3170H
		2-0	●	8x45	CONTROL RELEASE*	24	VCP7750E
 MH-1	31 mm	3-0	●	70		36	VCP245H
		2-0	●	70		36	VCP246H
		0	●	70		36	VCP247H
 MH	36 mm	3-0	●	70		36	VCP322H
		3-0	●	90		36	VCP100H
		2-0	●	70		36	VCP323H
		0	●	70		36	VCP324H
		0	●	90		36	VCP102H

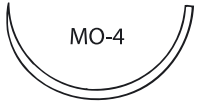

VICRYL* Plus
(Polyglactin 910) Braided Antibacterial

 **1/2 Circle Taper Point Needles (Heavier Wire Diameter)**

Needle	Gauge	Suture Color	Length (cm)	Other information	Number per box	Code
 UCLX 16 mm	3-0	●	70		36	VCPV13H
	2-0	●	70		36	VCP14H
	0	●	70		36	VCP15H
 MO-7 22 mm	1	●	70		36	VCP250H
	2	●	70		36	VCP251H
 CT-3 22 mm	3-0	●	70		36	VCPV327H
	0	●	70		36	VCP329H
 CT-2 26 mm	3-0	●	70		36	VCPV332H
	2-0	●	70		36	VCP333H
	2-0	●	90		36	VCP326H
	2-0	○	70		36	VCPV269H
	0	●	70		36	VCP334H
	0	○	70		36	VCP270H
	0	●	90		36	VCP330H
	0	●	8x45	CONTROL RELEASE*	24	VCP744E
	1	●	70		36	VCP335H
	2	●	70		36	VCP336H
 MO-5 31 mm	0	●	70		36	VCP9215H
	1	●	90		36	VCP253H
 CT-1 36 mm	3-0	●	70		36	VCP338H
	3-0	○	90		36	VCPV944H
	2-0	●	70		36	VCP339H
	2-0	●	90		36	VCP345H
	2-0	●	90		36	VCP945H
	0	●	70		36	VCP340H
	0	●	90		36	VCP346H
	0	○	90		36	VCP946H
	0	●	8x45	CONTROL RELEASE*	12	VCP740G
	1	●	70		36	VCP341H
	1	●	90		36	VCP347H
	1	●	4x70	CONTROL RELEASE*	12	VCP736G
	1	●	8x45	CONTROL RELEASE*	12	VCP741G
	2	●	90		36	VCP348H
	2	○	90		36	VCPV948H
	2	●	4x70	CONTROL RELEASE*	12	VCP737G
2	●	8x45	CONTROL RELEASE*	12	VCP742G	
 MO-4 36 mm	1	●	90		36	VCP437H
	2	●	90		36	VCP438H





1/2 Circle Taper Point Needles (Heavier Wire Diameter)						
Needle	Gauge	Suture Color	Length (cm)	Other information	Number per box	Code
 <p>CT</p> <p>40 mm</p>	3-0	●	70		36	VCPV350H
	2-0	●	70		36	VCP351H
	0	●	70		36	VCP352H
	0	●	90		36	VCP358H
	1	●	70		36	VCP353H
	1	●	90		36	VCP359H
	1	●	8x45	CONTROL RELEASE*	12	VCP753G
	2	●	90		36	VCP360H
	2	●	8x45	CONTROL RELEASE*	12	VCP754G
 <p>MO-45</p> <p>45 mm</p>	1	●	70		36	VCP9245H
	2	●	70		36	VCP9246H
 <p>CTX</p> <p>48 mm</p>	2-0	●	70		36	VCP363H
	0	●	90		36	VCP370H
	1	●	70		36	VCP365H
	1	●	90		36	VCP371H
	1	○	90		36	VCP366H
	1	●	8x45	CONTROL RELEASE*	12	VCP765G
	2	●	90		36	VCP372H
	2	○	90		36	VCP367H
 <p>TP-1</p> <p>65 mm</p>	2	●	4x70		6	VCP649
 <p>XLH</p> <p>70 mm</p>	2-0	●	70		12	VCP581G
	1	●	90		12	VCP5891G





VICRYL* Plus

(Polyglactin 910) Braided Antibacterial

1/2 Circle ETHIGUARD* Blunt Point Needles

Needle	Gauge	Suture Color	Length (cm)	Other information	Number per box	Code
 CTB-1 36 mm	1	●	90		36	VCP9995H
 CTB 40 mm	0	●	90		36	VCP9996H
	1	●	90		36	VCP9997H
 BT-3 45 mm	2	●	90		36	VCP9999H
 CTXB 48 mm	1	●	90		36	VCP9991H







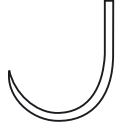
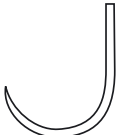

5/8 Circle Taper Point Needles

Needle	Gauge	Suture Color	Length (cm)	Other information	Number per box	Code
 UR-6 26 mm	2-0	●	70		36	VCP602H
	0	●	70		36	VCP603H
 UR-5 36 mm	2-0	●	70		36	VCP375H
	0	●	70		36	VCP376H

Fish Hook Needles

Needle	Gauge	Suture Color	Length (cm)	Other information	Number per box	Code
 V-38 31 mm	1	●	70	TAPERCUT*	36	VCP9335H
 ASH-35 35 mm	0	●	70		36	VCP9221H

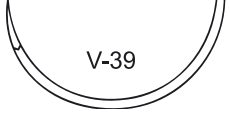
1/2 Circle TAPERCUT* Needles







Needle	Gauge	Suture Color	Length (cm)	Other information	Number per box	Code
 V-5 17 mm	4-0	●	70		36	VCP994H
	3-0	●	70		36	VCP276H
	1	●	70		36	VCP988H
 V-6 22 mm	2-0	●	70		36	VCP278H
 V-7 26 mm	3-0	●	70		36	VCP998H
	2-0	●	70		36	VCP999H
	0	●	70		36	VCP279H
 V-30 31 mm	2-0	●	70		36	VCP9360H
	0	●	70		36	VCP9361H
 V-34 36 mm	3-0	●	90		36	VCP516H
	2-0	●	90		36	VCP517H
	0	●	90		36	VCP518H
	1	●	90		36	VCP519H
	2	●	90		36	VCP520H
 V-37 40 mm	0	○	70		36	VCP9901H
	0	●	90		36	VCPW9467H
 V-39 45 mm	1	●	70		36	VCP9377H
 V-40 48 mm	2-0	●	90		36	VCP5020H
	1	●	150	LOOP	24	VCP829E

3/8 Circle TAPERCUT* Needles



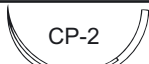

Needle	Gauge	Suture Color	Length (cm)	Other information	Number per box	Code
 V-4 17 mm	4-0	○	70		36	VCP240H

VICRYL* Plus
(Polyglactin 910) Braided Antibacterial





1/2 Circle Reverse Cutting Needles (Heavier Wire Diameter)

Needle	Gauge	Suture Color	Length (cm)	Other information	Number per box	Code	
 J-1	17 mm	4-0	●	75		36	VCPJV457H
 X-1	22 mm	3-0	●	45		36	VCP460H
		3-0	○	70		36	VCP458H
		2-0	○	70		36	VCP459H
 OS-4	22 mm	0	○	70	Heavy Needle	36	VCP694H
		1	○	70	Heavy Needle	36	VCP695H
		2	●	70	Heavy Needle	36	VCP9287H
 CP-2	26 mm	2-0	●	70		36	VCP969H
		0	●	70		36	VCP974H
 CP-1	36 mm	2-0	●	70		36	VCP466H
		2-0	○	90		36	VCP1472H
		0	●	70		36	VCP467H
		0	●	90		36	VCP473H
		1	●	70		36	VCP468H
		1	●	90		36	VCP474H
		2	●	90		36	VCP482H
 CP	40 mm	2-0	●	90		36	VCPJV484H
		0	●	70		36	VCP479H
		0	●	90		36	VCP485H
		1	●	70		36	VCP480H
		1	●	90		36	VCP486H
 CPX	48 mm	0	●	70		36	VCP9295H
		0	●	90		36	VCPV1057H
		1	●	90		36	VCP1058H
		2	●	90		36	VCP1059H

3/8 Circle Reverse Cutting PRIME* Needles

Needle	Gauge	Suture Color	Length (cm)	Other information	Number per box	Code	
 P-3	13 mm	5-0	○	45	MULTIPASS*	36	MPVCP493H
		5-0	○	45		36	VCP493H
		4-0	○	45	MULTIPASS*	36	MPVCP494H
		4-0	○	45		36	VCP494H
 PS-3	16 mm	5-0	○	45	MULTIPASS*	36	MPVCP500H
		5-0	○	45		36	VCP500H
 PS-2	19 mm	4-0	○	45	MULTIPASS*	36	MPVCP496H
		4-0	○	45		36	VCP496ZH
		3-0	○	45	MULTIPASS*	36	MPVCP497H
		3-0	○	45		36	VCP497H
 PS-2 S	19 mm	4-0	○	45	Slimmed	36	VCP496H

3/8 Circle Reverse Cutting PRIME* Needles							
Needle	Gauge	Suture Color	Length (cm)	Other information	Number per box	Code	
 PS-1	24 mm	3-0	○	45		36	VCP683H
		3-0	○	45	MULTIPASS*	36	MPVCP683H
		2-0	○	45		36	VCP684H

3/8 Circle Reverse Cutting Needles							
Needle	Gauge	Suture Color	Length (cm)	Other information	Number per box	Code	
 FS-2	19 mm	5-0	○	45		36	VCP291H
		5-0	●	45		36	VCP391H
		4-0	○	45		36	VCP292ZH
		4-0	●	45		12	VCP392ZG
		4-0	●	45		36	VCP392ZH
		4-0	○	70		36	VCP422H
		4-0	●	70		36	VCP397H
		3-0	○	45		36	VCP293H
		3-0	●	45		36	VCP393H
		3-0	○	70		36	VCP423H
		3-0	●	70		36	VCP398H
 FS-2S	19 mm	4-0	○	45	Slimmed	36	VCP292H
		4-0	●	45	Slimmed	36	VCP392H
 FS-1	24 mm	4-0	○	70		36	VCP441H
		4-0	●	70		36	VCP451H
		3-0	○	70		36	VCP442H
		3-0	●	70		36	VCP452H
		2-0	○	70		36	VCP443H
		2-0	●	70		36	VCP453H
 FSL	30 mm	3-0	●	70		36	VCP585H
		2-0	○	70		36	VCP589H
		2-0	●	70		36	VCP586H
		0	●	70		36	VCP587H

3/8 Circle Conventional Cutting PRIME* Needles							
Needle	Gauge	Suture Color	Length (cm)	Other information	Number per box	Code	
 PC-3	16 mm	5-0	○	45		36	VCP9505H
		4-0	○	45		36	VCP9506H

Straight Cutting Needles							
Needle	Gauge	Suture Color	Length (cm)	Other information	Number per box	Code	
 KS	60 mm	3-0	○	70		36	VCP663H

VICRYL* Plus
(Polyglactin 910) Braided Antibacterial

Ligatures						
	Gauge	Suture Color	Length (cm)	Other information	Number per box	Code
SUTUPAK*	4-0	●	2X70		24	VCPV623T
	3-0	●	2x70		24	VCP624E
	2-0	●	2x70		24	VCP625E
	0	●	2x70		24	VCP626E
	1	●	2x70		36	VCP627H
	2	●	2x70		36	VCP628H
SUTUPAK*	4-0	●	3x45		36	VCP633H
	4-0	○	3x45		36	VCPV643H
	3-0	●	3x45		36	VCP634H
	2-0	●	3x45		36	VCP635H
	0	●	3x45		24	VCP636E
	1	●	3x45		24	VCP637E
	2	●	3x45		36	VCP638H
SUTUPAK*	4-0	●	5x70		24	VCP1214E
	3-0	●	5x70		24	VCP1215E
	2-0	●	5x70		24	VCP1216E
	0	●	5x70		24	VCP1217E
	1	●	5x70		36	VCP1218H
	2	●	5x70		36	VCP1219H
SUTUPAK*	4-0	●	6x45		36	VCP1224H
	3-0	●	6x45		36	VCP1225H
	2-0	●	6x45		36	VCP1226H
	0	●	6x45		24	VCP1227E
	1	●	6x45		24	VCP1228E
	2	●	6x45		36	VCP1229H

PDS* II

(Polydioxanone) Suture



PDS* II

(Polydioxanone) Monofilament

SUTURE

Description: **Monofilament** For smooth passage through tissue.
Synthetic For minimal tissue reaction.
Absorbable By hydrolysis. Essentially complete in 182-238 days.

Tensile strength: **Post implantation** **Approximate % original strength remaining**

14 days	80% (3-0 and larger) 60% (4-0 and smaller)
28 days	70% (3-0 and larger) 40% (4-0 and smaller)
42 days	60% (3-0 and larger) 35% (4-0 and smaller)

Color: Violet or undyed.











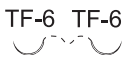































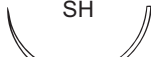







Range: 7-0 to 2 (USP). Supplied as needed sutures and ligatures.

Indications: PDS* II sutures are intended for use in general soft tissue approximation, including use in pediatric cardiovascular tissue, in microsurgery and in ophthalmic surgery. PDS* II sutures are particularly useful where the combination of an absorbable suture and extended wound support is desirable. Typical areas of use include:

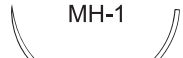
- Abdominal wall closure
- Intestinal anastomoses
- Ligament and tendon repair









































Full details in the Instruction for Use included in every package.





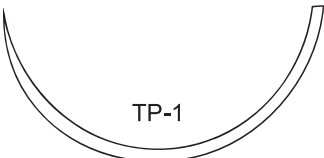

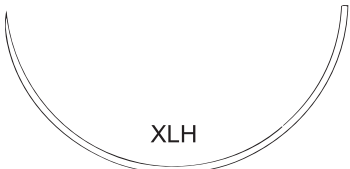
 1/2 Circle Taper Point Needles							
Needle	Gauge	Suture Color	Length (cm)	Other information	Number per box	Code	
 TF-6 TF-6 6,5 mm	7-0		70		24	Z1370E	
 TF-1 TF-1 10 mm	6-0		70		24	PUU2971E	
 RB-2 RB-2 13 mm	6-0		70		36	Z866H	
	5-0		70		36	Z867H	
 TF 13 mm	6-0		70		36	Z926H	
	5-0		70		36	Z925H	
	4-0		70		36	Z924H	
 TF TF 13 mm	5-0		70		36	Z935H	
 RB-1 17 mm	5-0		70		36	Z303H	
	4-0		70		36	Z304H	
	3-0		70		36	Z305H	
 RB-1 RB-1 17 mm	5-0		90		36	W9108H	
	4-0		70		36	Z864H	
	4-0		90		36	W9109H	
 SH-1 22 mm	4-0		70		36	Z310H	
	3-0		70		36	Z311H	
 SH-1 SH-1 22 mm	4-0		70		36	Z1310H	
	3-0		70		36	Z1311H	
 JB-1 VISI-BLACK 22 mm	4-0		70	VISI-BLACK*	36	Z3100H	
	4-0		4x70	CONTROL RELEASE*	12	X1154G	
	3-0		70	VISI-BLACK*	36	Z3110H	
 JB-1 JB-1 VISI-BLACK 22 mm	4-0		75	VISI-BLACK*	36	Z1312H	
 SH 26 mm	4-0		70		36	Z315H	
	3-0		70		36	Z316H	
	2-0		70		36	Z317H	
 SH SH 26 mm	3-0		70		36	Z1316H	
	2-0		90		36	Z528H	
 JB VISI-BLACK 26 mm	3-0		70	VISI-BLACK*	36	Z3160H	
	2-0		70	VISI-BLACK*	36	Z3170H	
 JB JB VISI-BLACK 26 mm	4-0		90	VISI-BLACK*	24	X976E	
	3-0		90	VISI-BLACK*	36	Z5270H	
 MH-1 31 mm	3-0		70		36	W9132H	
	2-0		150	Loop	36	PV2924SH	
 MH 36 mm	3-0		70		36	Z322H	
	2-0		70		36	Z323H	

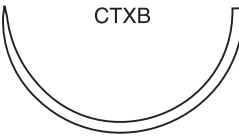

PDS* II

(Polydioxanone) Monofilament

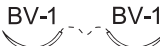
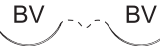
 1/2 Circle Taper Point Needles (Heavier Wire Diameter)						
Needle	Gauge	Suture Color	Length (cm)	Other information	Number per box	Code
 UCL 13 mm	3-0		70		36	Z113H
	2-0		70		36	Z114H
 UCLX 16 mm	3-0		70		36	Z13H
	2-0		70		36	Z14H
	0		70		36	Z15H
 CT-3 22 mm	2-0		70		36	Z328H
	0		70		36	Z329H
 CT-2 26 mm	2-0		70		36	Z333H
	0		70		36	Z334H
	1		70		36	Z335H
 CT-1 36 mm	3-0		70		36	Z338H
	2-0		70		36	Z339H
	2-0		150		12	Z1927G
	0		70		36	Z340H
	1		70		36	Z341H
 MO-2 40 mm	0		150	Loop	24	W9236T
	1		150	Loop	24	W9237T
 CT 40 mm	2-0		90		24	Z357E
	0		90		24	Z358E
	1		90		24	Z359E
 CTX 48 mm	0		90		24	Z370E
	0		150		12	Z1926G
	0		150	Loop	12	PN2925SG
	0		150	Loop	24	W9261T
	1		90		24	Z371E
	1		150	Loop	24	W9262T
	1		240	Loop	12	XN9263G
 TP-1 65 mm	0		150	Loop	12	PS2925SG
	1		150		12	PS2926G
 XLH 70 mm	0		70		12	Z582G

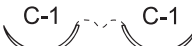
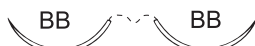
1/2 Circle ETHIGUARD* Blunt Point Needles							
Needle	Gauge	Suture Color	Length (cm)	Other information	Number per box	Code	
 BT-3	45 mm	1	●	90		24	W9965T
 CTXB	48 mm	0	●	150	Loop	24	W9966T
		1	●	150	Loop	24	W9967T

3/8 Circle Taper Point Needles							
Needle	Gauge	Suture Color	Length (cm)	Other information	Number per box	Code	
 BV175-8 VISI-BLACK	9,3 mm	7-0	●	70	VISI-BLACK*	24	Z161E
 BV-1	9,3 mm	7-0	●	70		24	Z1701E
		6-0	●	70		36	Z1702H
 BV	11 mm	6-0	●	70		36	Z1002H
 C-1	13 mm	6-0	●	70		36	Z1012H
		5-0	●	70		36	Z1013H
 C-1	13 mm	7-0	●	45		24	W9095T
		6-0	●	70		36	Z1721H
		5-0	●	70		36	Z1722H
 BB	17 mm	5-0	●	90		24	KCC2992E

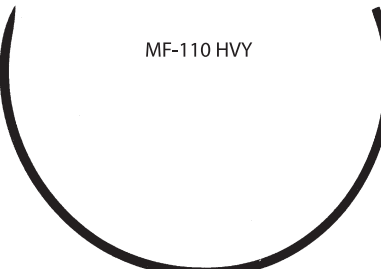



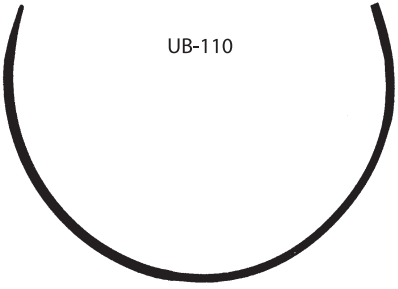

5/8 Circle Taper Point Needles							
Needle	Gauge	Suture Color	Length (cm)	Other information	Number per box	Code	
 UR-6	26 mm	2-0	●	70		36	VC2973H
 UR-6	26 mm	3-0	●	70		24	Z605E
 MF-110 HVY	110 mm	0	●	150	Loop	12	W9168

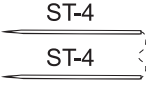
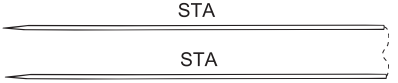

PDS* II

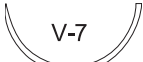





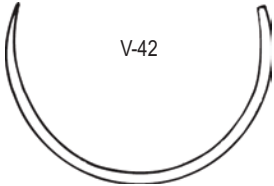

(Polydioxanone) Monofilament





5/8 Circle ETHIGUARD* Blunt Point Needles						
Needle	Gauge	Suture Color	Length (cm)	Other information	Number per box	Code
 <p>UB-110 110 mm</p>	0	●	240	Loop	12	W9968





Straight Taper Point Needles						
Needle	Gauge	Suture Color	Length (cm)	Other information	Number per box	Code
 <p>ST-4 19 mm</p>	5-0	●	35		36	BA2932H
 <p>ST-4 19 mm</p>	4-0	●	35		24	Z620E
 <p>STA 65 mm</p>	0	●	70		24	Z630E



1/2 Circle TAPERCUT* Needles						
Needle	Gauge	Suture Color	Length (cm)	Other information	Number per box	Code
 <p>V-5 17 mm</p>	5-0	●	70		36	Z995H
	4-0	●	70		36	Z994H
	3-0	●	70		36	Z276H
	2-0	●	70		36	Z274H
 <p>V-6 22 mm</p>	4-0	●	70		36	Z275H
	3-0	●	70		36	Z277H
 <p>V-7 26 mm</p>	4-0	●	70		36	Z997H
	3-0	●	70		36	Z998H
	2-0	●	70		36	Z999H
 <p>V-34 36 mm</p>	2-0	●	70		36	W9380H
	0	●	90		36	W9381H
	1	●	90		24	W9352T
 <p>V-37 40 mm</p>	0	●	150	Loop	24	Z1932E
 <p>V-40 48 mm</p>	0	●	150	Loop	12	OF2923SG

 5/8 Circle TAPERCUT* Needles						
Needle	Gauge	Suture Color	Length (cm)	Other information	Number per box	Code
 <p>V-42</p> <p>63 mm</p>	1		150	Loop	12	OT2924SG

 3/8 Circle CC-Needles						
Needle	Gauge	Suture Color	Length (cm)	Other information	Number per box	Code
 <p>CC</p> <p>9,3 mm</p>	7-0		70		24	Z1751E
 <p>CC CC</p> <p>9,3 mm</p>	7-0		70		24	Z1711E
	6-0		70		36	Z1712H
 <p>CC-1 CC-1</p> <p>13 mm</p>	6-0		70		36	Z1032H
	5-0		70		24	Z1033E



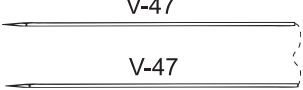



 3/8 Circle TAPERCUT* Needles						
Needle	Gauge	Suture Color	Length (cm)	Other information	Number per box	Code
 <p>V-18</p> <p>13 mm</p>	6-0		70		36	Z991H
	5-0		70		36	Z990H





 Fish hook TAPERCUT* Needles						
Needle	Gauge	Suture Color	Length (cm)	Other information	Number per box	Code
 <p>V-38</p> <p>31 mm</p>	0		70		24	W9333T
	1		70		24	W9334T



 Straight TAPERCUT* Needles						
Needle	Gauge	Suture Color	Length (cm)	Other information	Number per box	Code
 <p>V-47</p> <p>V-47</p> <p>38 mm</p>	4-0		35		24	Z425E



PDS* II



(Polydioxanone) Monofilament

1/2 Circle Reverse Cutting Needles (Heavier Wire Diameter)							
Needle	Gauge	Suture Color	Length (cm)	Other information	Number per box	Code	
 OS-4	22 mm	1	●	70	Heavy Needle	24	W9286T
 X-1	22 mm	3-0	○	70		24	Z458E
 CP-2	26 mm	2-0	●	70		36	Z969H
		0	●	70		36	Z983H
		1	●	70		36	Z984H
 CP-1	36 mm	2-0	●	70		36	Z466H
		0	●	70		36	Z467H
		1	●	70		36	Z468H
 CP	40 mm	0	●	90		24	Z485E
		1	●	90		24	W9324T
		2	●	70		24	MH2976E
 CPX	48 mm	0	●	90		24	Z1057E
		1	●	90		24	Z1058E

3/8 Circle Reverse Cutting PRIME* Needles							
Needle	Gauge	Suture Color	Length (cm)	Other information	Number per box	Code	
 P-1	11 mm	6-0	●	45		36	Z487H
		6-0	○	45		24	Z489E
		6-0	○	45	MULTIPASS*	36	MPZ489H
		5-0	○	45		24	Z490E
 P-3	13 mm	5-0	●	45		36	Z463H
		5-0	○	45		24	Z493E
		5-0	○	45	MULTIPASS*	36	MPZ493H
		4-0	●	45		36	Z464H
		4-0	○	45		24	Z494E
		4-0	○	45	MULTIPASS*	36	MPZ494H
 PS-3	16 mm	5-0	○	45	MULTIPASS*	36	MPZ500H
		5-0	○	45		24	W9872T
		4-0	○	45	MULTIPASS*	36	MPZ501H
		4-0	○	45		24	W9873T
 PS-2	19 mm	4-0	○	45		24	W9874T
		4-0	○	45	MULTIPASS*	36	MPZ496H
		3-0	○	45	MULTIPASS*	36	MPZ497H
		3-0	○	45		24	Z497E

3/8 Circle Reverse Cutting PRIME* Needles							
Needle	Gauge	Suture Color	Length (cm)	Other information	Number per box	Code	
 PS-2 S	19 mm	4-0	○	45	Slimmed	24	Z496E
		4-0	●	45	Slimmed	36	Z513H
 PS-1	24 mm	4-0	○	45	MULTIPASS*	36	MPZ682H
		3-0	○	45	MULTIPASS*	36	MPZ683H
		3-0	○	45		24	Z683E
		2-0	○	45		24	Z684E
 PS	26 mm	2-0	○	45	MULTIPASS*	36	MPZ9626H
		2-0	○	70		24	W9626T

3/8 Circle Reverse Cutting Needles							
Needle	Gauge	Suture Color	Length (cm)	Other information	Number per box	Code	
 FS-2	19 mm	5-0	○	70		24	Z421E
		4-0	●	30	Loop	36	Z282H
		3-0	○	45		24	Z293E
		3-0	○	70		24	Z423E
 FS-2S	19 mm	4-0	○	45	Slimmed	24	Z292E
		4-0	○	70	Slimmed	24	Z422E
 FS-1	24 mm	4-0	○	70		24	Z441E
		3-0	●	70		36	Z452H
		3-0	○	70		24	Z442E
		2-0	○	70		24	Z443E

3/8 Circle Conventional Cutting PRIME* Needles							
Needle	Gauge	Suture Color	Length (cm)	Other information	Number per box	Code	
 PC-1	13 mm	6-0	○	45		24	W9861T
 PCLX	36 mm	2-0	○	70		24	W9631T

1/2 Circle Reverse Cutting PRIME* Needles							
Needle	Gauge	Suture Color	Length (cm)	Other information	Number per box	Code	
 P-2	8 mm	5-0	●	45		36	JG2942H

PDS* II

(Polydioxanone) Monofilament

▼ Straight Cutting Needles

Needle	Gauge	Suture Color	Length (cm)	Other information	Number per box	Code
 KS 60 mm	4-0	○	70		36	Z662H
	3-0	○	70		36	Z663H
	2-0	○	70		36	Z664H

Ligatures

	Gauge	Suture Color	Length (cm)	Other information	Number per box	Code
SUTUPAK*	2-0	●	2x70		36	Z625H
	0	●	2x70		24	Z626E
	1	●	2x70		24	Z627E

PDS* Plus

(Polydioxanone) Antibacterial Monofilament



ETHICON

PART OF THE *Johnson & Johnson* FAMILY OF COMPANIES

PDS* PLUS

(Polydioxanone) Antibacterial Monofilament

SUTURE

Description: **Monofilament** For smooth passage through tissue.
Synthetic For minimal tissue reaction.
Absorbable By hydrolysis. Essentially complete in 182-238 days.

Tensile strength: **Post implantation** **Approximate % of original strength remaining**

14 days	80% (3-0 and larger)
	60% (4-0 and smaller)
28 days	70% (3-0 and larger)
	40% (4-0 and smaller)
42 days	60% (3-0 and larger)
	35% (4-0 and smaller)

Color: Violet or undyed

Range: 6-0 to 1 (USP). Supplied as needled sutures and ligatures.

Indications: PDS* Plus Antibacterial Sutures are intended for use in general soft tissue approximation, including in paediatric cardiovascular tissue, and in ophthalmic surgery (other than contact with cornea and sclera). PDS* Plus Antibacterial Sutures are particularly useful where the combination of absorbable suture and extended wound support is desirable. Typical areas of use include:











- Abdominal wall closure
- Intestinal anastomoses
- Ligament and tendon repair



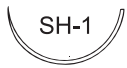
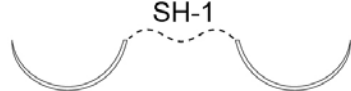

Protection against bacterial colonization

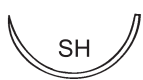
In vitro studies demonstrate, that PDS* Plus Antibacterial Suture has a zone of inhibition that is effective against the pathogens that most frequently cause surgical site infection, including Staphylococcus aureus, methicillin resistant Staphylococcus aureus (MRSA), Staphylococcus epidermidis, methicillin resistant Staphylococcus epidermidis (MRSE), E. coli and Klebsiella pneumoniae.

Full details in the Instruction for Use included in every package.





 1/2 Circle Taper Point Needles							
Needle	Gauge	Suture Color	Length (cm)	Other information	Number per box	Code	
 TF-1	10 mm	6-0	●	70	36	PDP2971H	
 RB-2	13 mm	5-0	●	70	36	PDP9201H	
 TF	13 mm	6-0	●	70	36	PDP926H	
		5-0	●	70	36	PDP925H	
		4-0	●	70	36	PDP924H	
 RB-1	17 mm	5-0	●	70	36	PDP303H	
		4-0	●	70	36	PDP304H	
		3-0	●	70	36	PDP305H	
 RB-1	17 mm	4-0	●	70	36	PDP864H	
 RB-1 VISI-BLACK	17 mm	5-0	●	70	VISI-BLACK*	36	PDP3060H
 SH-1	22 mm	4-0	●	70	36	PDP310H	
		3-0	●	70	36	PDP311H	
 SH-1	22 mm	4-0	●	70	36	PDP1310H	
		3-0	●	70	36	PDP1311H	
 JB-1	22 mm	4-0	●	70	VISI-BLACK*	36	PDP3100H
 JB-1 VISI-BLACK	22 mm	4-0	●	70	VISI-BLACK*	36	PDP1312H
 SH	26 mm	4-0	●	70	36	PDP315H	
		3-0	●	70	36	PDP316H	
		2-0	●	70	36	PDP317H	
 JB	26 mm	3-0	●	70	VISI-BLACK*	36	PDP3160H
		2-0	●	70	VISI-BLACK*	36	PDP3170H
 JB VISI-BLACK	26 mm	4-0	●	90	VISI-BLACK*	36	PDP976H
		3-0	●	90	VISI-BLACK*	36	PDP5270H

 1/2 Circle Taper Point Needles (Heavier Wire Diameter)							
Needle	Gauge	Suture Color	Length (cm)	Other information	Number per box	Code	
 UCLX	16 mm	0	●	70	36	PDP15H	
 CT-3	22 mm	2-0	●	70	36	PDP328H	
		0	●	70	36	PDP329H	
 CT-2	26 mm	2-0	●	70	36	PDP333H	
		0	●	70	36	PDP334H	
		1	●	70	36	PDP335H	
 CT-1	36 mm	3-0	●	70	36	PDP338H	
		2-0	●	70	36	PDP339H	
		0	●	70	36	PDP340H	
		0	●	90	36	PDPL955H	
		1	●	70	36	PDP341H	

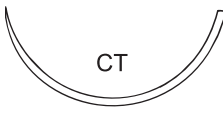

PDS* PLUS

(Polydioxanone) Antibacterial Monofilament

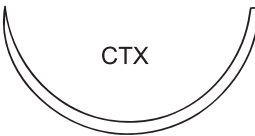
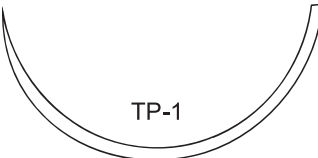
1/2 Circle Taper Point Needles (Heavier Wire Diameter)





Needle	Gauge	Suture Color	Length (cm)	Other information	Number per box	Code	
 CT	40 mm	2-0	●	90		36	PDP357H
		0	●	90		36	PDP358H
		1	●	90		36	PDP9234H
 MO-2	40 mm	0	●	150	Loop	24	PDP9236T
		1	●	150	Loop	24	PDP9237T
 CTX	48 mm	0	●	150		24	PDP1926T
		0	●	150	Loop	24	PDP925ST
		0	●	150	Loop	24	PDP9261T
		0	●	90		36	PDP370H
		1	●	150	Loop	24	PDP9262T
		1	●	90		36	PDP371H
 TP-1	65 mm	0	●	150	Loop	24	PDPS925ST
		1	●	150		24	PDPS926T

1/2 Circle ETHIGUARD* Blunt Point Needles

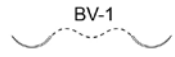
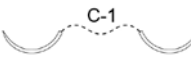



Needle	Gauge	Suture Color	Length (cm)	Other information	Number per box	Code	
 BT-3	45 mm	1	●	90		36	PDP9965H
 CTXB	48 mm	0	●	150	Loop	24	PDP9966T
		1	●	150	Loop	24	PDP9967T

3/8 Circle Taper Point Needles

Needle	Gauge	Suture Color	Length (cm)	Other information	Number per box	Code	
 BV-1	9,3 mm	6-0	●	70		36	PDP1702H
 C-1	13 mm	5-0	●	70		36	PDP1722H

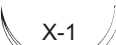

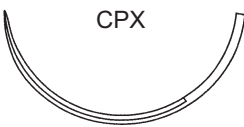

1/2 Circle TAPERCUT* Needles							
Needle		Gauge	Suture Color	Length (cm)	Other information	Number per box	Code
 V-6	22 mm	3-0	●	70		36	PDP277H
 V-7	26 mm	3-0	●	70		36	PDP9179H
		2-0	●	70		36	PDP9184H
 V-37	40 mm	0	●	150	Loop	24	PDP1932T
 V-40	48 mm	0	●	150	Loop	24	PDP1933T

Fish hook TAPERCUT* Needles							
Needle		Gauge	Suture Color	Length (cm)	Other information	Number per box	Code
 V-38	31 mm	0	●	70		36	PDP9333H
		1	●	70		36	PDP9334H

1/2 Circle Reverse Cutting Needles (Heavier Wire Diameter)							
Needle		Gauge	Suture Color	Length (cm)	Other information	Number per box	Code
 X-1	22 mm	3-0	○	70		36	PDP458H
 CP-2	26 mm	2-0	●	70		36	PDP969H
		0	●	70		36	PDP983H
		1	●	70		36	PDP984H
 CP-1	36 mm	2-0	●	70		36	PDP466H
		0	●	70		36	PDP467H
		1	●	70		36	PDP468H
 CP	40 mm	0	●	90		36	PDP485H
 CPX	48 mm	0	●	90		36	PDP1057H
		1	●	90		36	PDP9299H

PDS* PLUS

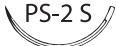
(Polydioxanone) Antibacterial Monofilament

3/8 Circle Reverse Cutting PRIME* Needles							
Needle	Gauge	Suture Color	Length (cm)	Other information	Number per box	Code	
 P-1	11 mm	5-0	○	45		36	PDP490H
 P-3	13 mm	5-0	○	45		36	PDP493H
		5-0	●	45		36	PDP463H
		4-0	○	45		36	PDP494H
 PS-2	19 mm	3-0	○	45		36	PDP497H
 PS-2 S	19 mm	4-0	○	45	Slimmed	36	PDP496H
 PS-1	24 mm	3-0	○	45		36	PDP683H
		2-0	○	45		36	PDP684H

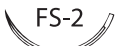
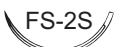
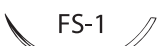
3/8 Circle Reverse Cutting Needles							
Needle	Gauge	Suture Color	Length (cm)	Other information	Number per box	Code	
 FS-2	19 mm	5-0	○	70		36	PDP421H
		4-0	○	45		36	PDP9950H
		3-0	○	70		36	PDP423H
 FS-2S	19 mm	4-0	○	70		36	PDP422H
 FS-1	24 mm	4-0	○	70		36	PDP441H
		3-0	○	70		36	PDP442H
		2-0	○	70		36	PDP443H

PROLENE*

Monofilament Polypropylene



ETHICON
PART OF THE *Johnson & Johnson* FAMILY OF COMPANIES

PROLENE*

Monofilament Polypropylene

SUTURE

Description: **Monofilament** For smooth passage through tissue.
Synthetic For minimal tissue reaction.
Non-absorbable Provides permanent tensile strength retention in tissue.

Color: Blue or clear.

Range: 10-0 to 2 (USP). Supplied as needled sutures, armed with, for example, EVERPOINT* Tungsten-Rhenium needles, VISI-BLACK* needles, MULTIPASS* needles or CC-needles. Also available with pledgets.

PROLENE* sutures are also available as HEMO-SEAL*, with suture diameter to needle diameter ratio close to 1. HEMO-SEAL* is particularly useful in reducing needle hole leakage (for example in synthetic vascular grafts).







Indications: PROLENE* sutures are intended for use in general soft tissue approximation and/or ligation, including use in cardiovascular, ophthalmic and neurosurgical procedures. Typical areas of use include:

- Cardiovascular anastomoses
- Subcuticular sutures

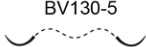
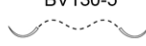

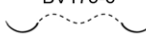
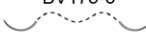

Full details in the Instruction for Use included in every package.

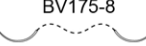



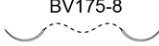



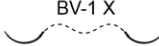
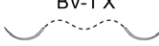
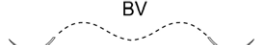
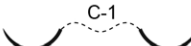
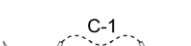





3/8 Circle Taper Point Needles

Needle	Gauge	Suture Color	Length (cm)	Other information	Number per box	Code
 VISI-BLACK	6,5 mm	8-0	45	VISI-BLACK*	12	X916G
		8-0	60	VISI-BLACK*	12	F1894
		8-0	75	VISI-BLACK*	24	EH7459E
		7-0	60	VISI-BLACK*	36	8207H
	6,5 mm	8-0	45	EVERPOINT*	36	EP8730H
		8-0	45	MULTIPASS*	24	EH7470E
		8-0	45	MULTIPASS*	12	W2777
		8-0	60	EVERPOINT*	36	EP8732H
		8-0	60	MULTIPASS*	36	KHH5662H
		8-0	75	MULTIPASS*	24	EH7469E
		8-0	75	Straight pack, MULTIPASS*	12	EH7469LG
		7-0	2x75	Straight pack, MULTIPASS*	12	KHL5673JG
	6,5 mm	8-0	13		12	W2775
		8-0	13	EVERPOINT*	12	EP2775G
 VISI-BLACK	8 mm	8-0	60	VISI-BLACK*	36	8841H
		7-0	60	VISI-BLACK*	36	8335H
		7-0	2x60	Straight pack, VISI-BLACK*	12	M8935
	8 mm	8-0	45	MULTIPASS*	36	8740H
		8-0	60	EVERPOINT*	36	EP8741H
		8-0	60	MULTIPASS*	36	8741H
		7-0	60	MULTIPASS*	36	8735H
		7-0	60	EVERPOINT*	36	EP8735H
		7-0	2X60	EVERPOINT*, Straight pack	12	EPM8737
		7-0	2x60	Straight pack, MULTIPASS*	12	M8737G
 VISI-BLACK	8 mm	8-0	2x60	Straight pack, VISI-BLACK*	12	M8967
	8 mm	7-0	60		36	8766H
		7-0	2x60	Straight pack	12	M8766
 VISI-BLACK	9,3 mm	7-0	45	VISI-BLACK*	36	EH7225H
		7-0	75	VISI-BLACK*	36	EH7222H
		7-0	2x75	Straight pack, VISI-BLACK*	12	MEH7224JG
		7-0	4x60	Straight pack, VISI-BLACK*	12	X967G
	9,3 mm	7-0	45	EVERPOINT*	36	EP8746H
		7-0	45	MULTIPASS*	36	8701H
		7-0	60	EVERPOINT*	36	EP8747H
		7-0	60	MULTIPASS*	12	W8702



PROLENE*
Monofilament Polypropylene

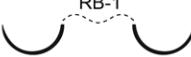

 3/8 Circle Taper Point Needles						
Needle	Gauge	Suture Color	Length (cm)	Other information	Number per box	Code
 BV175-8 9,3 mm	7-0	●	75	EVERPOINT*	36	EP8755H
	7-0	●	75	MULTIPASS*	36	EH7405H
	7-0	●	4X60	EVERPOINT*, Straight pack	12	EPM8745
	7-0	●	4x60	Straight pack, MULTIPASS*	12	W8702S
	7-0	●	4x75	Straight pack, MULTIPASS*	12	M8702G
 BV175-8 9,3 mm	7-0	●	75	MULTIPASS*	36	EH7402H
 BV-1 VISI-BLACK 9,3 mm	7-0	●	60	VISI-BLACK*	12	W8304
	7-0	●	2x60	VISI-BLACK*, Straight pack	12	KAA5663LG
	6-0	●	60	VISI-BLACK*	12	W8305
	6-0	●	75	VISI-BLACK*	36	EH7223H
 BV-1 9,3 mm	7-0	●	60	EVERPOINT*	36	EP8702H
	6-0	●	75	EVERPOINT*	36	EP8709H
	6-0	●	60	EVERPOINT*	36	EP8805H
	6-0	●	75		36	EH7406H
 BV-1 9,3 mm	6-0	●	75		36	EH7403H
 BV-1 X VISI-BLACK 9,3 mm	7-0	●	75	VISI-BLACK*, Heavier Wire Diameter	36	EH7238H
	6-0	●	75	VISI-BLACK*, Heavier Wire Diameter	36	EH7240H
 BV-1 X 9,3 mm	6-0	●	75	Heavier Wire Diameter	36	EH7245H
 BV 11 mm	6-0	●	75		36	8776H
 C-1 VISI-BLACK 13 mm	6-0	●	45	VISI-BLACK*	36	X577H
	6-0	●	60	VISI-BLACK*	12	W8307
	6-0	●	75	VISI-BLACK*	36	EH7228H
	6-0	●	90	VISI-BLACK*	36	EH7230H
	6-0	●	2x75	Straight pack, VISI-BLACK*	12	MEH7232JG
	5-0	●	75	VISI-BLACK*	36	EH7229H
	5-0	●	90	VISI-BLACK*	36	EH7231H
	5-0	●	2x75	Straight pack, VISI-BLACK*	12	MEH7233JG
 C-1 13 mm	7-0	●	60		12	W8725
	7-0	●	75		36	8708H
	6-0	●	60		12	W8718
	6-0	●	75		36	8706H
	6-0	●	75	EVERPOINT*	36	EP8706H
	6-0	●	4X75	EVERPOINT*, Straight pack	12	EPM8706
	6-0	●	2x90	Straight pack	12	KBL5690JG
	5-0	●	45		36	8717H
	5-0	●	60		36	KBB5661H
	5-0	●	70	Pledget	12	KBB5671VG
	5-0	●	75		36	EH7477H
	5-0	●	90		36	8720H
	5-0	●	2x90	Straight pack	12	KBL5691JG
	4-0	●	75		36	EH7478H

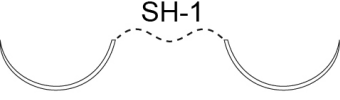
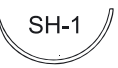

3/8 Circle Taper Point Needles							
Needle	Gauge	Suture Color	Length (cm)	Other information	Number per box	Code	
 VISI-BLACK	13 mm	6-0	75	VISI-BLACK*	36	EH7226H	
		5-0	75	VISI-BLACK*	36	EH7227H	
	13 mm	6-0	75	EVERPOINT*	36	EP8889H	
		6-0	75		36	8889H	
		5-0	75		36	8890H	
		4-0	75		36	EH7476H	
 VISI-BLACK	13 mm	5-0	75	VISI-BLACK*, Heavier Wire Diameter	36	EH7257H	
	13 mm	5-0	75	Heavier Wire Diameter	36	EH7255H	
	13 mm	5-0	75	Heavier Wire Diameter	36	EH7254H	
	17 mm	5-0	90		36	8580H	
		4-0	90		36	8581H	
	17 mm	5-0	75		36	8880H	
		4-0	75		36	8881H	

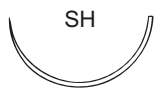
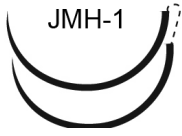
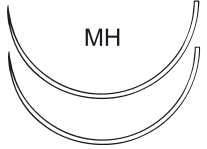

1/2 Circle Taper Point Needles							
Needle	Gauge	Suture Color	Length (cm)	Other information	Number per box	Code	
	6,5 mm	7-0	45		24	EH7813E	
		7-0	75		36	PQQ5671H	
		6-0	45		24	EH7814E	
		6-0	60		24	PQQ5660E	
	10 mm	6-0	75		36	EH7835H	
		5-0	60		36	PUU5662SH	
	13 mm	6-0	45		36	8714H	
		6-0	75		36	8711H	
		5-0	75		36	8710H	
		5-0	4x75	Straight pack	12	M8710G	
	13 mm	6-0	75		36	EH7400H	
		5-0	60		36	8205H	
		5-0	75		36	EH7401H	
		5-0	75	2x2 mm firm pledget	36	EH7412H	
		4-0	90		36	EH7411H	
 VISI-BLACK	17 mm	5-0	90	VISI-BLACK*	36	VB50H	
		4-0	90	VISI-BLACK*	36	8357H	
	17 mm	5-0	90		36	8556H	
		4-0	90		36	8557H	
		3-0	90		36	8558H	
	17 mm	5-0	75		36	8870H	
		4-0	75		36	8871H	
		3-0	75		36	8872H	

PROLENE*
Monofilament Polypropylene

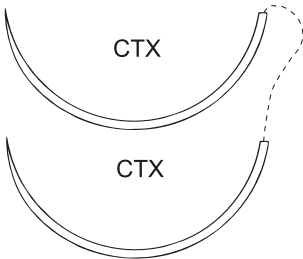

1/2 Circle Taper Point Needles							
Needle	Gauge	Suture Color	Length (cm)	Other information	Number per box	Code	
 VISI-BLACK	22 mm	5-0	●	90	Pledgets, VISI-BLACK*	36	EH8066H
		4-0	●	90	Pledgets, VISI-BLACK*	36	EH8065H
	22 mm	4-0	●	90		36	EH7585H
		3-0	●	90		36	EH7586H
	22 mm	4-0	●	75		36	EH7581H
		3-0	●	75		36	EH7582H
 VISI-BLACK	26 mm	4-0	●	90	VISI-BLACK*	36	EH8087H
		4-0	●	90	Pledgets, VISI-BLACK*	36	EH8062H
		4-0	●	120	VISI-BLACK*	36	X1166H
		3-0	●	90	Pledgets, VISI-BLACK*	36	EH8061H
		3-0	●	90	VISI-BLACK*	36	EH8086H
	26 mm	4-0	●	90		36	8521H
		4-0	●	90	Pledgets, Straight pack	12	EH7190LG
		3-0	●	90		36	8522H
		3-0	●	120		36	EH7584H
		2-0	●	90		36	8523H
	26 mm	4-0	●	75		36	8831H
		3-0	●	75		36	8832H
		2-0	●	75		36	8833H
		0	●	75		36	8834H
 VISI-BLACK	31 mm	3-0	●	120	VISI-BLACK*	36	X1295H
		3-0	●	90	VISI-BLACK*	36	EH8091H
	36 mm	3-0	●	90		36	EH7499H
		3-0	●	120		36	PGG5613H
		2-0	●	90		36	PGG5694H
		2-0	●	120		36	PGG5614H
		0	●	90		36	PGG5695H

1/2 Circle Taper Point Needles (Heavier Wire Diameter)							
Needle	Gauge	Suture Color	Length (cm)	Other information	Number per box	Code	
	26 mm	2-0	●	75		36	8411H
		0	●	75		36	8412H
		1	●	90		36	PK5696H
	36 mm	3-0	●	75		36	8422H
		2-0	●	75		36	8423H
		0	●	75		36	8424H
		1	●	75		36	8425H





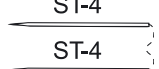

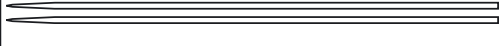



1/2 Circle Taper Point Needles (Heavier Wire Diameter)							
Needle	Gauge	Suture Color	Length (cm)	Other information	Number per box	Code	
 CT	40 mm	0	●	75		36	8434H
		1	●	100		12	W742
 CTX	48 mm	0	●	90		36	PN5695H
		1	●	150	Loop	12	8527G
 CTX CTX	48 mm	0	●	90		24	PNN5695E



Compound Curve Taper Point Needles							
Needle	Gauge	Suture Color	Length (cm)	Other information	Number per box	Code	
 ABV-1	9,3 mm	7-0	●	75		36	EH8000H
 AC-1	13 mm	6-0	●	75		36	EH8010H
		5-0	●	75		36	EH8014H

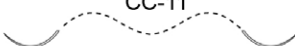
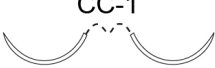

5/8 Circle Taper Point Needles							
Needle	Gauge	Suture Color	Length (cm)	Other information	Number per box	Code	
 UR-6	26 mm	2-0	●	75		36	VC5673H



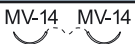

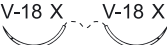

Straight Taper Point Needles							
Needle	Gauge	Suture Color	Length (cm)	Other information	Number per box	Code	
 ST-4 ST-4	19 mm	4-0	●	35		36	EH7508H
 ST-1 ST-1	45 mm	3-0	●	35		36	EH7921H
 ST-70	70 mm	2-0	●	75		12	W8400

PROLENE*
Monofilament Polypropylene

 3/8 Circle CC-Needles						
Needle	Gauge	Suture Color	Length (cm)	Other information	Number per box	Code
 CC175-6 	8 mm	8-0	●	60	VISI-BLACK*	12 W8101
 CC / CC175-8	8-0	●	60		24	EH7972E
	8-0	●	60	MULTIPASS*	12	W8703
	8-0	●	60	EVERPOINT*	36	EP7972H
	7-0	●	45		36	8705H
	7-0	●	75	EVERPOINT*	36	EP8812SLH
	7-0	●	75	MULTIPASS*	36	8704H
	6-0	●	75	EVERPOINT*	36	EP8811H
	6-0	●	60	EVERPOINT*	36	EP8807H
	6-0	●	60	MULTIPASS*	12	W8807
	5-0	●	60	HEMOSEAL*	12	W8662
 CC	9,3 mm	7-0	●	75		36 EH7970H
 CCX 	9,3 mm	7-0	●	75	VISI-BLACK*, Heavier Wire Diameter	36 EH7237H
	6-0	●	75	VISI-BLACK*, Heavier Wire Diameter	36	EH7234H
 CCX	9,3 mm	7-0	●	75	EVERPOINT*	36 EP8812H
	7-0	●	75	Heavier Wire Diameter	36	EH7236H
	6-0	●	75	Heavier Wire Diameter	36	EH7235H
 CC-11	11 mm	6-0	●	60		12 W8802
 CC-1	6-0	●	45		36	8719H
	6-0	●	75	MULTIPASS*	36	8707H
	6-0	●	2x75	MULTIPASS*, Straight pack	12	X535G
	5-0	●	75		36	EH7977H
	5-0	●	75	MULTIPASS	36	7475H
	5-0	●	90		36	8721H
 CC-1	13 mm	6-0	●	75		36 EH7975H
	5-0	●	75		36	EH7976H
 CC-1 X	13 mm	5-0	●	75	Heavier Wire Diameter	36 EH7251H

 3/8 Circle TAPERCUT* Needle						
Needle	Gauge	Suture Color	Length (cm)	Other information	Number per box	Code
 MV-14	5,5 mm	8-0	●	60		24 EH7828E
 V-18	13 mm	6-0	●	75		36 EH7474H
	5-0	●	75		36	EH7475H
 V-18	13 mm	6-0	●	75		36 EH7471H
	5-0	●	75		36	EH7472H
 V-18 X	13 mm	5-0	●	75	Heavier Wire Diameter	36 EH7253H

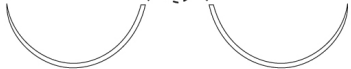
3/8 Circle TAPERCUT* Needle						
Needle	Gauge	Suture Color	Length (cm)	Other information	Number per box	Code
 V-4 17 mm	5-0	●	75		36	F2829
	4-0	●	75		36	F2828
	4-0	●	90		36	8925H
 V-4 17 mm	5-0	●	75		36	8941H
	4-0	●	75		36	8942H
	3-0	●	75		36	8943H
 V-26 26 mm	3-0	●	90		36	EH7788H



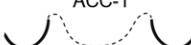



1/2 Circle CC-Needles						
Needle	Gauge	Suture Color	Length (cm)	Other information	Number per box	Code
 CC-6 11 mm VISI-BLACK	7-0	●	60	VISI-BLACK*	12	X1004G
 CC-4 13 mm VISI-BLACK	6-0	●	75	VISI-BLACK*	36	EH7242H
	5-0	●	75	VISI-BLACK*	36	EH7241H
	5-0	●	2x75	VISI-BLACK*, Straight pack	12	MEH7241JG
 CC-4 13 mm	6-0	●	60	MULTIPASS*	12	W8815
	5-0	●	75		12	W8816
	5-0	●	60	HEMO-SEAL*	12	W8664
	4-0	●	75	HEMO-SEAL*	12	W8665
 CC-16 16 mm	3-0	●	90	HEMO-SEAL*	12	W8667
 CC-25 26 mm	4-0	●	90		12	W8845
 CC-30 31 mm	3-0	●	90		12	W8849

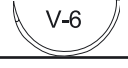

Compound Curve CC-Needles						
Needle	Gauge	Suture Color	Length (cm)	Other information	Number per box	Code
 ACC 9,3 mm VISI-BLACK	7-0	●	60	VISI-BLACK*	36	EH8020H
	7-0	●	75	VISI-BLACK*	24	EH8021E
	6-0	●	75	ACC + ACC-1	36	EH8035H
	6-0	●	75	VISI-BLACK*	36	EH8025H
 ACC-1 13 mm VISI-BLACK	6-0	●	75	VISI-BLACK*	36	EH8030H
	6-0	●	90	VISI-BLACK*	36	EH8031H
	6-0	●	2x75	Straight pack	12	MEH8034JG
	5-0	●	75	VISI-BLACK*	36	EH8036H
	5-0	●	90	VISI-BLACK*	36	EH8037H

PROLENE*



Monofilament Polypropylene

Compound Curve CC-Needles							
Needle	Gauge	Suture Color	Length (cm)	Other information	Number per box	Code	
 VISI-BLACK	13 mm	6-0	●	75	VISI-BLACK*	36	EH8032H





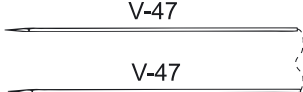



























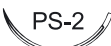









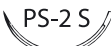

1/2 Circle TAPERCUT* Needles						
Needle	Gauge	Suture Color	Length (cm)	Other information	Number per box	Code
	5-0	●	90		36	8934H
	4-0	●	90		36	8935H
	4-0	●	90	Straight pack, Pledgets	12	8954G
	4-0	●	2x90	Straight pack	12	OAL5693JG
	3-0	●	90		36	8936H
	2-0	●	90		36	8937H
	5-0	●	75		36	8951H
	4-0	●	75		36	8952H
	3-0	●	75		36	8953H
	4-0	●	90		36	EH7774H
	3-0	●	90		36	EH7775H
	2-0	●	75		36	EH7772H
	4-0	●	90		36	8975H
	4-0	●	120		36	F2840
	3-0	●	90		36	8976H
	3-0	●	90	Pledgets	36	OBB5694SH
	3-0	●	2x90	Straight pack	12	OBL5694JG
	3-0	●	120		36	EH7778H
	2-0	●	90		36	8977H
	2-0	●	4x90	Straight pack, Pledgets	12	OBL5595LG
	2-0	●	4x90	Straight pack	12	OBL5695LG
	2-0	●	120		36	EH7779H
	0	●	120		36	OBB5616H
	4-0	●	75		36	8962H
	3-0	●	75		36	8963H
	2-0	●	75		36	8964H
	2-0	●	75		36	8443H
	0	●	75		36	8444H

Compound Curve TAPERCUT* Needles							
Needle	Gauge	Suture Color	Length (cm)	Other information	Number per box	Code	
 VISI-BLACK	9,3 mm	7-0	●	45	VISI-BLACK*	12	18541G
 VISI-BLACK	13 mm	6-0	●	45	VISI-BLACK*	12	18543G







Straight TAPERCUT* Needles





Needle	Gauge	Suture Color	Length (cm)	Other information	Number per box	Code
 V-47 38 mm	4-0		35		36	8592H

3/8 Circle Reverse Cutting PRIME* Needles

Needle	Gauge	Suture Color	Length (cm)	Other information	Number per box	Code
 P-6 8 mm	7-0		45		36	8648H
	6-0		45		24	W8000T
 P-1 11 mm	7-0		75	MULTIPASS*	36	MPP2854H
	6-0		45		36	8697H
	6-0		45	MULTIPASS*	36	MPP8697H
 P-3 13 mm	6-0		45		36	8695H
	6-0		45	MULTIPASS*	36	MPP8695H
	5-0		45		36	8698H
	5-0		45	MULTIPASS*	36	MPP8698H
	5-0		75	MULTIPASS*	36	MPP2858H
	4-0		45		36	8699H
	4-0		45	MULTIPASS*	36	MPP8699H
	4-0		45		36	JA5742H
 PS-3 16 mm	4-0		45	MULTIPASS*	36	MPP8604H
	6-0		75	MULTIPASS*	36	MPP2832H
	5-0		45		36	8681H
	5-0		45	MULTIPASS*	36	MPP8681H
	4-0		45		36	EH7764H
 PS-2 19 mm	4-0		45	MULTIPASS*	36	MPP7764H
	5-0		45		24	W8014T
	5-0		45	MULTIPASS*	36	MPP8686H
	4-0		45		24	W8015T
	4-0		45	MULTIPASS*	36	MPP8682H
	4-0		75	MULTIPASS*	36	MPP2834H
	4-0		75	MULTIPASS*	36	MPP2861H
	3-0		60	MULTIPASS*	36	MPP2835H
	3-0		75		36	EH7691H
 PS-2 S 19 mm	3-0		75	MULTIPASS*	36	MPP2862H
	4-0		45	Slimmed	36	8682H
 PS-1 24 mm	4-0		45		36	EH7758H
	4-0		75	MULTIPASS*	36	MPP7695H
	3-0		45	MULTIPASS*	36	MPP7757H
	3-0		60		12	EH7666G
	3-0		75		36	EH7568H
 PS 26 mm	2-0		45	MULTIPASS*	36	MPP8026H
 PSL 30 mm	2-0		75		36	EH7121H



PROLENE*
Monofilament Polypropylene







▼ 3/8 Circle Reverse Cutting Needles							
Needle	Gauge	Suture Color	Length (cm)	Other information	Number per box	Code	
 M-3 VISI-BLACK	16 mm	6-0	●	45	VISI-BLACK*	12	8750G
 FS-3	16 mm	6-0	●	45		36	8660H
		5-0	●	45		36	8614H
 FS-2	19 mm	5-0	●	45		36	8661H
		4-0	●	45		36	EH7151H
		4-0	●	75		36	EH7150H
		3-0	●	45		36	8665H
		3-0	●	75		36	EH7693H
 FS-1	24 mm	4-0	●	45		36	8629H
		3-0	●	45		36	8684H
		3-0	●	60		12	EH7963G
		3-0	●	75		36	EH7694H
 FS	26 mm	2-0	●	45		36	8685H
 FSL	30 mm	4-0	●	75		36	8670H
		3-0	●	75		36	8675H
		2-0	●	75		36	EH7697H
		0	●	45		36	EH7920H
 FSLX	36 mm	3-0	●	75		36	8649H
		2-0	●	75		36	8689H
		0	●	75		36	EH7561H

▲ 3/8 Circle Conventional Cutting PRIME* Needles							
Needle	Gauge	Suture Color	Length (cm)	Other information	Number per box	Code	
 PC-3	16 mm	6-0	●	45		24	W8873T
		6-0	●	45	MULTIPASS*	36	MPP8873H
		5-0	●	45		12	W527
		5-0	●	45		24	W8874T
		5-0	●	45	MULTIPASS*	36	MPP8874H
		4-0	●	45		12	W525
		4-0	●	45		24	W8007T
		4-0	●	45	MULTIPASS*	36	MPP8875H
 PC-5	19 mm	5-0	●	45	MULTIPASS*	36	MPP8876H
		4-0	●	45		24	W8877T
		4-0	●	45	MULTIPASS*	36	MPP8877H
 PC-25	26 mm	4-0	●	45		24	W8879T
		3-0	●	45		12	W538
 PCLX	36 mm	3-0	●	75	With locking buttons	12	W8626





1/2 Circle Reverse Cutting PRIME* Needles							
Needle	Gauge	Suture Color	Length (cm)	Other information	Number per box	Code	
 PS-4 16 mm	4-0	●	45		36	EH7759H	

1/2 Circle Reverse Cutting Needles							
Needle	Gauge	Suture Color	Length (cm)	Other information	Number per box	Code	
 J-1 17 mm	3-0	●	45		36	EH7545H	

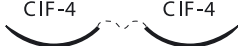

Straight Cutting Needles							
Needle	Gauge	Suture Color	Length (cm)	Other information	Number per box	Code	
 SC-1 13 mm	4-0	●	45		36	EH7730H	
 KS 60 mm	3-0	●	75	With locking buttons	12	W8630	
	3-0	●	75	With beads and collars	12	W630	
	3-0	●	75		36	8622H	
	2-0	●	75		36	8623H	



3/8 Circle Taper Point Needles Special							
Needle	Gauge	Suture Color	Length (cm)	Other information	Number per box	Code	
 BV75-3 3,8 mm	10-0	●	13		12	W2790	
 BV130-4 4,7 mm	9-0	●	13		12	W2780	
	8-0	●	13		12	W2779	
 BV-6 4,8 mm	10-0	●	10		12	EH7595G	
 BV-4 4,9 mm	10-0	●	15		12	EH7596G	
 BV100-4 5,1 mm	10-0	●	13		12	W2794	
	9-0	●	13		12	W2783	
 BV100-4 5,1 mm	9-0	●	45		12	F1891	
 BV-2 6,5 mm	9-0	●	15		12	EH7597G	





1/4 Circle TAPERCUT* Needles							
Needle	Gauge	Suture Color	Length (cm)	Other information	Number per box	Code	
 CIF-4 13 mm	10-0	●	20		12	788G	

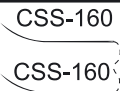



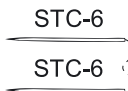

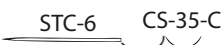

3/8 Circle MICROPPOINT* Spatula							
Needle	Gauge	Suture Color	Length (cm)	Other information	Number per box	Code	
 GS-12 5,5 mm	10-0	●	30		12	EH7473G	
 GS-12 5,5 mm	10-0	●	30		12	EH7598G	
 CS-35-C 6 mm	10-0	●	30		12	EH7984G	
 GS-9 6,5 mm	9-0	●	15		12	1754G	

PROLENE*
Monofilament Polypropylene

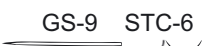
 1/4 Circle CS ULTIMA* Spatula							
Needle	Gauge	Suture Color	Length (cm)	Other information	Number per box	Code	
 CTC-6 L 13 mm	10-0		10		12	EH7897G	

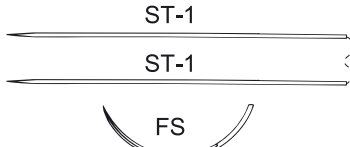
 Ski MICROPOINT* Spatula							
Needle	Gauge	Suture Color	Length (cm)	Other information	Number per box	Code	
 CSS-160 16 mm	10-0		30		12	EH7997G	

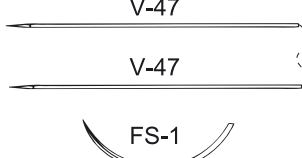
 Straight MICROPOINT* Spatula							
Needle	Gauge	Suture Color	Length (cm)	Other information	Number per box	Code	
 STC-6 16 mm	10-0		20		12	1713G	
 STC-6 16 mm	10-0		15	Loop	12	EH7900G	

Special Combinations							
Needle	Gauge	Suture Color	Length (cm)	Other information	Number per box	Code	
 STC-6 CS-35-C 16 mm + 6 mm	10-0		20		12	ET5631SG	
 GS-9 STC-6 6,5 mm + 16 mm	9-0		20		12	1753G	
 ST-1 45 mm + 45 mm + 26 mm FS	3-0		35	Loop with polypropylene button. Pull-out tendon suture for Bunnell technique.	12	EH7922G	
 V-47 38 mm + 38 mm + 26 mm FS-1	4-0		35	Loop with polypropylene button. Pull-out tendon suture for Bunnell technique.	12	EH7668G	

PRONOVA*

(Poly(hexafluoropropylene-VDF)) Suture



ETHICON
PART OF THE *Johnson & Johnson* FAMILY OF COMPANIES

PRONOVA*

Poly(hexafluoropropylene-VDF)

SUTURE

Description: **Monofilament** For smooth passage through tissue.
 Synthetic For minimal tissue reaction.
 Non-absorbable Provides permanent tensile strength retention in tissue.

Color: Blue.



Range: 8-0 to 5-0 (USP). Supplied as needled sutures, armed with, for example, VISI-BLACK* needles or CC-needles.







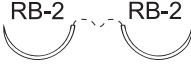

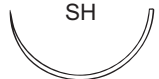

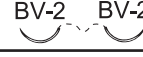
Indications: PRONOVA* sutures are intended for use in general soft tissue approximation and/or ligation, including use in cardiovascular, ophthalmic and neurosurgical procedures. Typical areas of use include:

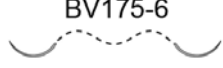
- Vascular anastomoses

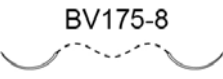
Full details in the Instruction for Use included in every package.







1/2 Circle Taper Point Needles							
Needle	Gauge	Suture Color	Length (cm)	Other information	Number per box	Code	
	13 mm	6-0	●	75	36	PN8606H	
		5-0	●	75	36	PN8500H	
	17 mm	5-0	●	75	36	PN1800H	
		5-0	●	90	36	PN8510H	
	26 mm	5-0	●	75	36	PN1821H	
	26 mm	5-0	●	75	36	PN1837H	



3/8 Circle Taper Point Needles							
Needle	Gauge	Suture Color	Length (cm)	Other information	Number per box	Code	
	6,5 mm	8-0	●	45	12	PN1836G	
	6,5 mm	8-0	●	75	VISI-BLACK*	24	PN8809E
	8 mm	8-0	●	60	12	PN1890G	
		7-0	●	60	36	PN1889H	
	9,3 mm	7-0	●	45	VISI-BLACK*	36	PN8700H
		7-0	●	60	VISI-BLACK*	36	PN8706H
		6-0	●	60	VISI-BLACK*	36	PN8613H
		6-0	●	75	VISI-BLACK*	36	PN1852H
	9,3 mm	7-0	●	60	MULTIPASS*	36	PN8714H
		7-0	●	75	MULTIPASS*	36	PN8709H
		6-0	●	75		36	PN8612H
	13 mm	7-0	●	75	VISI-BLACK*	36	PN8704H
		6-0	●	75	VISI-BLACK*	36	PN1855H
		5-0	●	75	VISI-BLACK*	36	PN1856H
		5-0	●	90	VISI-BLACK*	36	PN8522H
	13 mm	6-0	●	60		36	PN8619H
		6-0	●	75		36	PN8602H
		5-0	●	75		36	PN8506H
	13 mm	6-0	●	75		36	PN8607H
		5-0	●	75		36	PN8502H
	17 mm	5-0	●	75	VISI-BLACK*	36	PN1859H
		5-0	●	90	VISI-BLACK*	36	PN1863H
	17 mm	5-0	●	75		36	PN1830H
		5-0	●	90		36	PN1860H

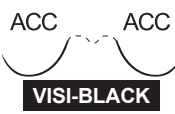
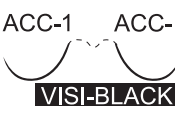

PRONOVA*

Poly(hexafluoropropylene-VDF)

 3/8 Circle CC-Needles							
Needle	Gauge	Suture Color	Length (cm)	Other information	Number per box	Code	
	9,3 mm	8-0	●	60		12	PN8803G
		7-0	●	60		36	PN1839H
		7-0	●	75		36	PN1831H
		6-0	●	60		36	PN1809H
	13 mm	6-0	●	60		36	PN8605H
		6-0	●	75		36	PN1811H
		5-0	●	75		36	PN1812H
		5-0	●	90		36	PN8516H

 Compound Curve CC-Needles							
Needle	Gauge	Suture Color	Length (cm)	Other information	Number per box	Code	
	9,3 mm	7-0	●	75	VISI-BLACK*	36	PN8715H
		6-0	●	75	VISI-BLACK*	36	PN8622H
	13 mm	6-0	●	75	VISI-BLACK*	36	PN8623H
		5-0	●	75	VISI-BLACK*	36	PN8529H

 3/8 Circle TAPERCUT* Needles							
Needle	Gauge	Suture Color	Length (cm)	Other information	Number per box	Code	
	13 mm	5-0	●	75		36	PN8520H

 1/2 Circle TAPERCUT* Needles							
Needle	Gauge	Suture Color	Length (cm)	Other information	Number per box	Code	
	17 mm	5-0	●	75		36	PN2872H

ETHILON*

(Polyamide 6) Suture



ETHICON
PART OF THE *Johnson & Johnson* FAMILY OF COMPANIES

ETHILON*

Monofilament Polyamide 6

SUTURE

Description: **Monofilament** For smooth passage through tissue.
 Synthetic For minimal tissue reaction.
 Non-absorbable Provides prolonged tensile strength retention in tissue.

Color: Blue, black or clear.







Range: 11-0 to 2 (USP). Supplied as needled sutures armed with, for example, MULTIPASS* and PRIME* needles. ETHILON* is also available as ligatures.

Indications: ETHILON* (black and clear) sutures are intended for use in general soft tissue approximation and/or ligation, including use in cardiovascular, ophthalmic, microsurgical and neurosurgical procedures. Blue ETHILON* sutures are intended for use in skin closure. Typical areas of use include:

- Cuticular sutures
- Nerve adaptation
- Ophthalmology

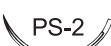
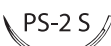

Full details in the Instruction for Use included in every package.













3/8 Circle Reverse Cutting PRIME* Needles							
Needle	Gauge	Suture Color	Length (cm)	Other information	Number per box	Code	
 P-6	8 mm	7-0	●	45		36	1647H
 P-1	11 mm	7-0	●	45		36	1696H
		7-0	●	45	MULTIPASS*	36	MPE1696H
		6-0	●	45		36	697H
		6-0	●	45	MULTIPASS*	36	MPE697H
 P-3	13 mm	6-0	●	45		36	1698H
		6-0	●	45	MULTIPASS*	36	MPE1698H
		5-0	●	45		36	698H
		5-0	●	45		36	EH7800H
		5-0	●	45	MULTIPASS*	36	MPE698H
		5-0	●	45	MULTIPASS*	36	MPE7800H
		5-0	●	45		24	W1852T
		4-0	○	45		36	691H
		4-0	●	45		36	699H
		4-0	●	45		36	EH7801H
		4-0	●	45	MULTIPASS*	36	MPE7801H
		 PS-3	16 mm	6-0	●	45	MULTIPASS*
6-0	●			45		24	W1614T
5-0	●			45		36	EH7930H
5-0	●			45	MULTIPASS*	36	MPE7930H
4-0	●			45		36	EH7931H
4-0	●			45	MULTIPASS*	36	MPE7931H
4-0	●			45		24	W1861T
 PS-2	19 mm	5-0	●	45		36	EH7804H
		5-0	●	45	MULTIPASS*	36	MPE7804H
		4-0	●	45		36	EH7162H
		4-0	●	45		24	W1620T
		4-0	●	45	MULTIPASS*	36	MPE1667H
		4-0	●	45	MULTIPASS*	36	MPE1855H
		3-0	●	45		36	W1621T
		3-0	●	45	MULTIPASS*	36	MPE1621H
 PS-2 S	19 mm	4-0	●	45	SLIMMED	36	1667H
 PS-1	24 mm	4-0	●	45		36	EH7957H
		4-0	●	75		36	EH7956H
		4-0	●	75	MULTIPASS*	36	MPE7956H
		3-0	●	45		24	W1857T
		3-0	●	75		36	EH7954H
		3-0	●	75	MULTIPASS*	36	MPE7954H





ETHILON*





Monofilament Polyamide 6

3/8 Circle Reverse Cutting PRIME* Needles						
Needle	Gauge	Suture Color	Length (cm)	Other information	Number per box	Code
 PS 26 mm	3-0	●	45	MULTIPASS*	36	MPE1625H
	3-0	●	45		24	W1625T
	3-0	●	75		24	W1685T
	2-0	●	75		24	W1626T
 PSL 30 mm	3-0	●	75		36	EH7113H
 PSLX 36 mm	3-0	●	75		24	W1627T

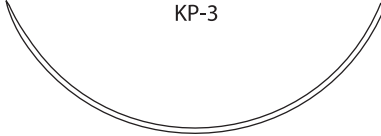
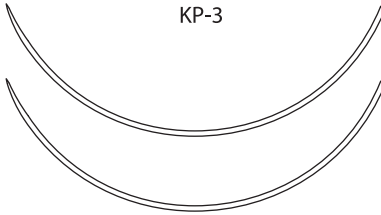
3/8 Circle Reverse Cutting Needles						
Needle	Gauge	Suture Color	Length (cm)	Other information	Number per box	Code
 C-2 13 mm	6-0	●	45		36	667H
	5-0	●	45		36	EH7945H
 M-2 13 mm	5-0	●	45		36	644H
 FS-3 16 mm	6-0	●	45		36	660H
	6-0	●	45	VISI-BLACK*	36	EH7177H
	5-0	●	45		36	1628H
	5-0	●	45		36	EH7823H
	4-0	●	45		36	EH7824H
 FS-2 19 mm	5-0	●	45		36	EH7790H
	4-0	●	45		36	EH7144H
	4-0	●	45		36	EH7145H
	4-0	●	75		36	EH7143H
	3-0	●	45		36	EH7792H
	2-0	●	90		36	F3217
 FS-2S 19 mm	4-0	○	45	SLIMMED	36	611H
	4-0	●	45	SLIMMED	36	EH7791H
 FS-1 24 mm	5-0	●	45		36	EH7640H
	4-0	●	45		36	EH7825H
	4-0	●	45		36	S2450
	4-0	●	75		36	FJ5272H
	3-0	●	45		36	EH7794H
	3-0	●	75		36	EH7795H
	2-0	●	45		36	EH7826H
	2-0	●	45		36	EH7826H
 FS 26 mm	4-0	●	45		36	FK5242H
	3-0	●	45		36	ES163H
	2-0	●	45		36	EH7796H
 FSL 30 mm	4-0	●	75		36	1670H
	3-0	●	45		36	EH7936H
	3-0	●	75		36	EH7939H
	3-0	●	45		36	S2455
	2-0	●	75		36	EH7798H

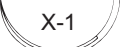

▼ 3/8 Circle Reverse Cutting Needles							
Needle	Gauge	Suture Color	Length (cm)	Other information	Number per box	Code	
 FSLX 36 mm	3-0	●	75		36	1673H	
	2-0	●	75		36	1674H	
	0	●	75		36	EH7809H	
 LR-60 60 mm	2-0	●	100		12	W558	
 LR 76 mm	2	●	3x50		12	3460TG	

▲ 3/8 Circle Conventional Cutting PRIME* Needles							
Needle	Gauge	Suture Color	Length (cm)	Other information	Number per box	Code	
 PC-1 13 mm	6-0	●	45		36	JM5140H	
 PC-3 16 mm	6-0	●	45	MULTIPASS*	36	MPE1853H	
	6-0	●	45		24	W1615T	
	5-0	●	45	MULTIPASS*	36	MPE1616H	
	5-0	●	45		24	W1616T	
	5-0	●	45		24	W1854T	
 PC-5 19 mm	4-0	●	45	MULTIPASS*	36	MPE1856H	
	4-0	●	45		24	W1856T	
 PC-25 26 mm	6-0	●	45		24	W1859T	
	5-0	●	45		24	W1858T	
 KP-3 90 mm	2-0	●	100		12	W795	
	1	●	100		12	W797	
	1	●	2x50	With retention tubing	12	W2797	
 KP-3 90 mm	1	●	75		12	W689	



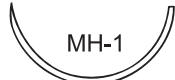

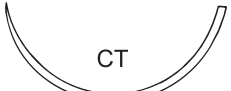











▼ 1/2 Circle Reverse Cutting Needles (Heavier Wire Diameter)						
Needle	Gauge	Suture Color	Length (cm)	Other information	Number per box	Code
 M-1 13 mm	5-0	●	45		36	648H
 J-1 17 mm	5-0	●	75		36	F2423
 X-1 22 mm	3-0	●	45		36	EH7943H
 CPX 48 mm	1	●	100		12	W738





▲ Straight Cutting Needles						
Needle	Gauge	Suture Color	Length (cm)	Other information	Number per box	Code
 KS 60 mm	3-0	●	75		36	627H
	2-0	●	75		36	628H



◎ 1/2 Circle Taper Point Needles						
Needle	Gauge	Suture Color	Length (cm)	Other information	Number per box	Code
 MH-1 31 mm	0	●	150	Loop	12	W739

◎ 1/2 Circle Taper Point Needles (Heavier Wire Diameter)						
Needle	Gauge	Suture Color	Length (cm)	Other information	Number per box	Code
 CT 40 mm	0	●	200	Loop	12	W760
 CTX 48 mm	1	●	150	Loop	12	W748

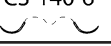

◎ Straight Taper Point Needles						
Needle	Gauge	Suture Color	Length (cm)	Other information	Number per box	Code
 STAW 65 mm	2-0	●	75		24	EH7625E

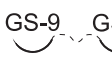
 3/8 Circle Taper Point Needles							
Needle		Gauge	Suture Color	Length (cm)	Other information	Number per box	Code
BV 140-3 	3,7 mm	10-0	●	15	Non-sterile	12	NS2820
BV130-3 	3,7 mm	9-0	●	13		12	FG2819
BV75-3 	3,8 mm	10-0	●	13		12	W2870
		9-0	●	13		12	W2871
BV50-3 	3,8 mm	11-0	●	13		12	W2881
BV130-4 	4,7 mm	9-0	●	13		12	W2813
		8-0	●	13		12	W2812
BVH100-3 	4,7 mm	10-0	●	13	1/2 circle	12	W2860
BV75-4 	5,1 mm	10-0	●	13		12	W2850
BV-6 	5,1 mm	11-0	●	10		12	EH7438G
BV-4 	5,1 mm	10-0	●	15		12	2814G
BV100-4 	5,1 mm	10-0	●	13		12	W2830
		9-0	●	13		12	W2829
		9-0	●	15		12	EH7448G
BV-2 	6,5 mm	10-0	●	15		12	2810G
		9-0	●	15		12	2809G
		8-0	●	15		12	2808G
BV130-5 	6,5 mm	10-0	●	13		12	W2810
		8-0	●	13		12	W2808
BV130-5 	6,5 mm	10-0	●	30		12	W2801
BV175-6 	8 mm	8-0	●	45		12	W8170
BV-1 	9,3 mm	7-0	●	45		36	EH7446H
C-1 	13 mm	6-0	●	75		36	EH7500H

 3/8 Circle CS ULTIMA* Spatula							
Needle		Gauge	Suture Color	Length (cm)	Other information	Number per box	Code
UCS-35 	6,2 mm	10-0	●	15		12	7060G
CS-140-6 	6,5 mm	10-0	●	30		12	U7003
CS-140-6 	6,5 mm	10-0	●	30		12	U7061

▼ 3/8 Circle MICROPOINT* Spatula						
Needle	Gauge	Suture Color	Length (cm)	Other information	Number per box	Code
 CS-35-C	6 mm	10-0	●	15		12 EH7980G
 GS-9	6,5 mm	10-0	●	30		12 1718G
		9-0	●	30		12 1717G
 TG140-6	6,5 mm	11-0	●	30		12 W1780
		10-0	●	30		12 W1770
		9-0	●	30		12 W1769

▼ 1/2 Circle MICROPOINT* Reverse Cutting Needles						
Needle	Gauge	Suture Color	Length (cm)	Other information	Number per box	Code
 G-7	8 mm	8-0	●	45		12 W1765

▼ 1/2 Circle MICROPOINT* Spatula						
Needle	Gauge	Suture Color	Length (cm)	Other information	Number per box	Code
 TG160-6	5,5 mm	10-0	●	30		12 W1756
 TG175-8	7 mm	8-0	●	30		12 1716G

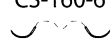
◀ 1/2 Circle CS ULTIMA* Spatula						
Needle	Gauge	Suture Color	Length (cm)	Other information	Number per box	Code
 CS-160-6	5,5 mm	10-0	●	30		12 U7000

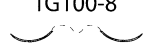
▼ 1/4 Circle MICROPOINT* Spatula						
Needle	Gauge	Suture Color	Length (cm)	Other information	Number per box	Code
 TG100-8	6,5 mm	8-0	●	30		12 B7714

▼ 1/4 Circle Spatula Needles						
Needle	Gauge	Suture Color	Length (cm)	Other information	Number per box	Code
 S-14	8 mm	5-0	●	20		36 MN5132H



1/4 Circle TAPERCUT* Needles

Needle	Gauge	Suture Color	Length (cm)	Other information	Number per box	Code	
V100-3 	3,5 mm	10-0	●	13		12	W2899
		9-0	●	13		12	W2898
V150-4 	4,5 mm	10-0	●	15		12	W1701

Ligatures

	Gauge	Suture Color	Length (cm)	Other information	Number per box	Code
SUTUPAK*	4-0	●	3x45		36	EH6751H
	3-0	●	10x45		36	EH6562H
LIGAPAK*	2-0	●	250	Reel	20	F4354

ETHIBOND* Excel

(Polybutylate Coated Polyester) Suture



ETHICON
PART OF THE *Johnson & Johnson* FAMILY OF COMPANIES

ETHIBOND* Excel

Polybutylate Coated Polyester

SUTURE

Description:

Braided Coated	For easy handling and secure knot tying. For smooth tie down and easy passage through tissue.
Synthetic	For minimal tissue reaction.
Non-absorbable	Provides permanent tensile strength retention in tissue.

Color: Green or white.











Range: 7-0 to 6 (USP). Supplied as needled sutures or ligatures. With or without pledgets.

Indications: ETHIBOND* sutures are intended for use in general soft tissue approximation and/or ligation, including use in cardiovascular, ophthalmic and neurosurgical procedures. Typical areas of use include:

- Heart valve fixation
- Ligament and tendon repair
- Retraction sutures

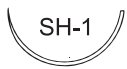
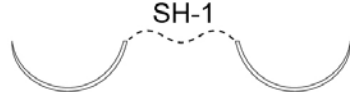
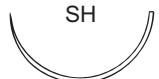

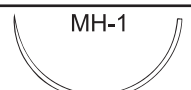

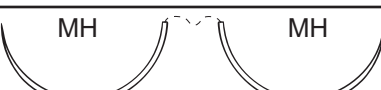

Full details in the Instruction for Use included in every package.







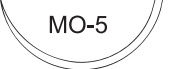

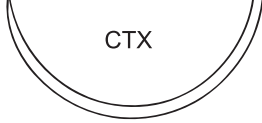
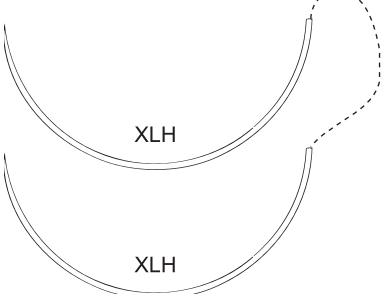
 1/2 Circle Taper Point Needles							
Needle	Gauge	Suture Color	Length (cm)	Other information	Number per box	Code	
 RB-2 RB-2	13 mm	5-0	●	75		36	6710H
 TF	13 mm	4-0	●	75		36	EH7417H
		4-0	●	8x45	CONTROL RELEASE*	24	CB84E
 TF TF	13 mm	4-0	●	45	Pledgets	36	EH7420H
 RB-1	17 mm	5-0	●	75		36	6870H
		4-0	●	75		36	6871H
		3-0	●	75		36	6872H
		2-0	●	75		36	6873H
 RB-1 RB-1	17 mm	5-0	●	75		36	6550H
		4-0	●	75		36	E6551H
		3-0	●	90		36	6558H
		2-0	●	90		12	W6760
 SH-1	22 mm	4-0	●	75		36	EH7397H
		3-0	●	75		36	EH7398H
		2-0	●	75		36	EH7399H
 SH-1	22 mm	3-0	●	90		36	E6762H
 SH	26 mm	4-0	●	75		36	W6831
		3-0	●	75		36	6832H
		2-0	●	75		36	6833H
		0	●	75		36	6834H
		0	●	120		36	PF6315H
		1	●	75		36	EH7528H
 SH SH	26 mm	4-0	●	90		36	6521H
		3-0	●	90		36	6522H
		2-0	●	90		36	6523H
		2-0	●	90	6x3 mm pledgets	36	P6523H
		2-0	●/○	10x75		6	W10B82
		0	●	90		36	6524H
 MH-1	31 mm	0	●	75		12	W975
 MH	36 mm	2-0	●	75		36	EH7490H
		0	●	75		36	EH7491H
 MH MH	36 mm	2-0	●	90		36	B843H

ETHIBOND* Excel

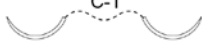



Polybutylate Coated Polyester

 1/2 Circle Taper Point Needles (Heavier Wire Diameter)							
Needle		Gauge	Suture Color	Length (cm)	Other information	Number per box	Code
 UCL	13 mm	1	●	75		36	EH7497H
 MO-7	22 mm	2	●	75		36	EH7845H
 CT-2	26 mm	2-0	●	75		36	6411H
		0	●	75		36	EB2316H
 MO-6	26 mm	2	●	75		36	TB6377H
		2	●/○	4x75		24	4TB7177E
 MO-5	31 mm	2	●	75		36	TC6377H
 CT-1	36 mm	0	●	75		36	6424H
		1	●	75		36	6425H
 CT-1	36 mm	0	●	75		36	PLL6375H
 CTX	48 mm	1	●	75		36	PN6376H
 XLH	70 mm	1	●	75		12	X190G

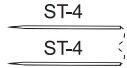
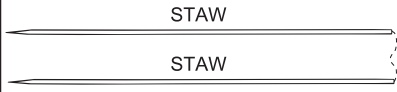
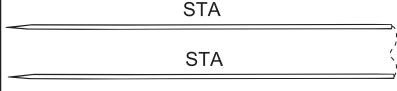
 3/8 Circle Taper Point Needles							
Needle		Gauge	Suture Color	Length (cm)	Other information	Number per box	Code
 BV-1	9,3 mm	7-0	●	75		36	EH7427H
 C-1	13 mm	6-0	●	75		36	6889H
		5-0	●	75		36	6890H
 C-1	13 mm	5-0	●	75		36	E6717H
 BB	17 mm	4-0	●	75		36	6881H

 Fish Hook Taper Point Needles						
Needle	Gauge	Suture Color	Length (cm)	Other information	Number per box	Code
 ASH-30 30 mm	1	●	75		12	W969





 Straight Taper Point Needles						
Needle	Gauge	Suture Color	Length (cm)	Other information	Number per box	Code
 ST-4 ST-4 19 mm	4-0	●	35		36	EH7418H
 STAW STAW 65 mm	0	●	75		24	BLL6375E
 STA STA 65 mm	3	●	75		12	EH7479G

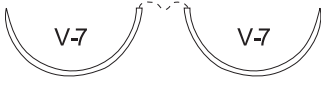

 1/2 Circle TAPERCUT* Needles							
Needle	Gauge	Suture Color	Length (cm)	Other information	Number per box	Code	
 V-5 17 mm	5-0	●	75		36	6951H	
	4-0	●	75		36	EH7384H	
	3-0	●	75		36	6953H	
	2-0	●	75		36	6954H	
 V-5 V-5 17 mm	4-0	●	75		36	6935H	
	4-0	●/○	4x75		12	MEH7719LG	
	3-0	●	75		36	6936H	
	3-0	●/○	4x75		12	6959G	
	2-0	●	75		36	6937H	
	2-0	●	75	6x3 mm pledgets	36	P6937H	
	2-0	●	4x75		12	6937LG	
	2-0	●/○	4x75		12	EH7712LG	
	2-0	●/○	4x75	6x3 mm pledgets	12	EH7715LG	
	2-0	●/○	4x75	3x3 mm soft pledgets	12	PX1011	
	2-0	●	8x75	6x3 mm pledgets	6	MEH6937N	
	2-0	●/○	8x75		6	MEH7712N	
	2-0	●/○	8x75	6x3 mm pledgets	6	MEH7715N	
	2-0	●/○	10x75	3x3 mm pledgets	6	W10B54	
	 V-7 26 mm	3-0	●	75		36	6963H
2-0		●	75		36	6964H	
0		●	75		36	6965H	

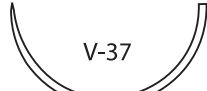

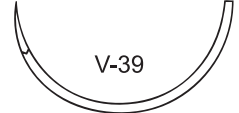
ETHIBOND* Excel

Polybutylate Coated Polyester





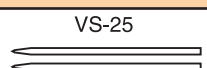

1/2 Circle TAPERCUT* Needles							
Needle	Gauge	Suture Color	Length (cm)	Other information	Number per box	Code	
 V-7 V-7 26 mm	4-0	●	75		36	B975H	
	3-0	●	75		36	6976H	
	2-0	●	75		36	6977H	
	2-0	○	75		36	6987H	
	2-0	●	90		12	W6977	
	2-0	●	75		6x3 mm pledgets	36	P6977H
	2-0	●/○	4x75			12	EH7711LG
	2-0	●/○	4x75		6x3 mm pledgets	12	EH7716LG
	2-0	●/○	4x75		3x3 mm soft pledgets	12	PX1010
	2-0	●/○	8x75		6x3 mm pledgets	6	MEH7716N
	2-0	●/○	10x75		6x3 mm pledgets	6	W10B77
	2-0	●/○	10x90		6x3 mm pledgets	6	KV91
	2-0	●/○	10x90			6	KV31
	2-0	●/○	4x90		6x3 mm pledgets	12	MEH7710LG
	0	●	90			12	W6978
	0	●/○	8x90		6x3 mm pledgets	6	MEH7717N

1/2 Circle TAPERCUT* Needles (Heavier Wire Diameter)						
Needle	Gauge	Suture Color	Length (cm)	Other information	Number per box	Code
 V-34 36 mm	1	●	90		36	EB4407H
 V-37 40 mm	2	●	75		12	869G
 BPT-2 40 mm	6	●	75		12	RS72G
 V-39 45 mm	2	●	4x75		12	W4843
 BPT-1 48 mm	6	●	75		12	RS71G
 V-55 55 mm	5	●	75		12	BE3294
	5	●	4x75		12	W4846

3/8 Circle TAPERCUT* Needles						
Needle	Gauge	Suture Color	Length (cm)	Other information	Number per box	Code
 V-4 17 mm	4-0	●	75		36	E6942H
	3-0	●	75		36	6943H
	2-0	●	75		36	6944H
 V-4 V-4 17 mm	2-0	●	75		36	B927H
	2-0	●	90		36	HAA6395H
	2-0	●	90	6x3 mm pledgets	36	X32200







Compound Curve TAPERCUT* Needles						
Needle	Gauge	Suture Color	Length (cm)	Other information	Number per box	Code
 DA-1 13 mm VISI-BLACK	4-0	●	45	VISI-BLACK*	12	18537G
 DA 25 mm VISI-BLACK	4-0	●	45	VISI-BLACK*	12	18536G



Straight TAPERCUT* Needles						
Needle	Gauge	Suture Color	Length (cm)	Other information	Number per box	Code
 VS-25 25 mm	4-0	○	45		12	W6584

1/2 Circle Reverse Cutting Needles (Heavier Wire Diameter)						
Needle	Gauge	Suture Color	Length (cm)	Other information	Number per box	Code
 X-1 22 mm	3-0	●	75		36	EH7678H
	2-0	●	75		36	EH7679H
 OS-4 22 mm	0	●	75	HEAVY NEEDLE	36	6517H
	1	●	75	HEAVY NEEDLE	36	6518H
 OS-4 22 mm	2	●	90	HEAVY NEEDLE	12	W6748
 CP-2 26 mm	0	●	75		36	EH7673H
 CP-1 36 mm	0	●	75		36	X32049
	1	●	75		36	EH7674H
 CP 40 mm	0	●	75		36	EB2236H

ETHIBOND* Excel

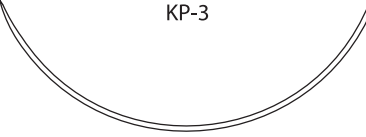
Polybutylate Coated Polyester

3/8 Circle Reverse Cutting Needles						
Needle	Gauge	Suture Color	Length (cm)	Other information	Number per box	Code
 FS-2 19 mm	5-0	●	45		36	6661H
	3-0	●	45		36	EH7346H
 FS-2S 19 mm	4-0	●	45	Slimmed	36	6683H
 FS-1 24 mm	3-0	●	45		36	6663H
 FS 26 mm	2-0	●	45		36	6664H
 FSL 30 mm	0	●	75		36	EH7688H
 FSLX 36 mm	0	●	75		36	EH7562H
 LR 76 mm	5	●	50		12	B409TG
 KP-3 90 mm	2-0	●	100	Conventional cutting	12	W993

3/8 Circle Reverse Cutting PRIME* Needles						
Needle	Gauge	Suture Color	Length (cm)	Other information	Number per box	Code
 P-1 11 mm	6-0	●	45		36	6697H
 P-3 13 mm	5-0	●	45		36	6698H
	4-0	●	45		36	EH7573H
	4-0	○	45		36	JA6442H
 PS-3 16 mm	5-0	●	45		36	6681H
	4-0	●	45		36	EH7760H

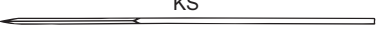
Straight Cutting Needles						
Needle	Gauge	Suture Color	Length (cm)	Other information	Number per box	Code
 KS 60 mm	3-0	●	75		36	EH7722H
	1	●	75		36	X32030

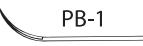
Ski Cutting Needles						
Needle	Gauge	Suture Color	Length (cm)	Other information	Number per box	Code
 PB-1 22 mm	3-0	●	45		36	EH7579H

Ligatures						
	Gauge	Suture Color	Length (cm)	Other information	Number per box	Code
LIGAPAK*	5	●	125	REEL	20	SP4491
SUTUPAK*	3-0	●	2x70		36	EH6453H
	2-0	●	2x70		36	EH6454H
	0	●	2x70		36	EH6455H
	1	●	2x70		36	EH6456H
	2	●	2x70		36	EH6457H
	3	●	2x70		36	EH6458H
	5	●	2x70		36	EH6459H
SUTUPAK*	4-0	●	3x45		36	EH6432H
	3-0	●	3x45		36	EH6433H
	2-0	●	3x45		36	EH6434H
	0	●	3x45		36	EH6435H
	1	●	3x45		36	EH6436H
	2	●	3x45		36	EH6437H
SUTUPAK*	3-0	●	5x70		36	EH6523H
	2-0	●	5x70		36	EH6524H
	0	●	5x70		36	EH6525H
SUTUPAK*	5-0	●	6x45		36	EH6441H
	0	●	6x45		36	EH6445H
SUTUPAK*	5-0	●	12x45		36	EH6371H
	4-0	●	12x45		36	EH6372H
	2-0	●	12x45		36	EH6374H
	0	●	12x45		24	EH6375E

MERSILENE*

(Polyester) Suture



ETHICON
PART OF THE *Johnson & Johnson* FAMILY OF COMPANIES

MERSILENE*

Polyester

SUTURE

Description: Braided For easy handling and secure knot tying.
Synthetic For minimal tissue reaction.
Non-absorbable Provides permanent tensile strength retention in tissue.

Color: Green or white.

Range: 10-0 to 3 (USP). Supplied as needed sutures or ligatures. Size 10-0 is monofilament in structure.



Indications: MERSILENE* sutures are intended for use in general soft tissue approximation and/or ligation, including use in cardiovascular, ophthalmic and neurosurgical procedures. Typical areas of use include:

- Dental surgery
- Ophthalmic surgery
- Ligation

Full details in the Instruction for Use included in every package.

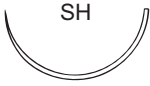

1/2 Circle Taper Point Needles

Needle	Gauge	Suture Color	Length (cm)	Other information	Number per box	Code
 RB-1 17 mm	4-0	●	75		36	R871H
	3-0	●	75		36	R872H
 SH 26 mm	3-0	●	75		36	R832H
	2-0	●	75		36	R833H
	0	●	75		36	R834H
	1	●	75		36	EH7526H
 MH 36 mm	2-0	●	75		36	R843H
	0	●	75		36	R844H
	1	●	75		36	R845H
 CT-1 36 mm	0	●	75		36	R424H

Straight Taper Point Needles

Needle	Gauge	Suture Color	Length (cm)	Other information	Number per box	Code
 ST-4 19 mm	3-0	●	75		12	EH7413G

1/2 Circle TAPERCUT* Needles

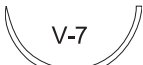

Needle	Gauge	Suture Color	Length (cm)	Other information	Number per box	Code
 V-5 17 mm	4-0	●	45		12	18513G
	3-0	●	45		12	18506G
 V-7 26 mm	2-0	●	75		36	R964H

3/8 Circle TAPERCUT* Needles



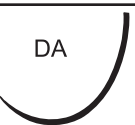

Needle	Gauge	Suture Color	Length (cm)	Other information	Number per box	Code
 V-4 17 mm	3-0	●	75		36	R943H

Compound Curve TAPERCUT* Needles

Needle	Gauge	Suture Color	Length (cm)	Other information	Number per box	Code
 DA-1 13 mm VISI-BLACK	4-0	●	45	VISI-BLACK*	12	18533G
 DA 25 mm VISI-BLACK	4-0	●	45	VISI-BLACK*	12	18528G

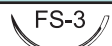
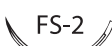
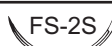

▼ 1/2 Circle Reverse Cutting Needles							
Needle	Gauge	Suture Color	Length (cm)	Other information	Number per box	Code	
 CP-2	26 mm	0	●	75		36	EH7325H
 CP-1	36 mm	1	●	75		36	EH7350H

▼ 3/8 Circle Reverse Cutting PRIME* Needles							
Needle	Gauge	Suture Color	Length (cm)	Other information	Number per box	Code	
 P-3	13 mm	4-0	○	45		36	R691H

▼ 3/8 Circle Reverse Cutting Needles							
Needle	Gauge	Suture Color	Length (cm)	Other information	Number per box	Code	
 FS-3	16 mm	5-0	●	45		36	R670H
 FS-2	19 mm	4-0	●	45		36	EH7147H
		4-0	○	45		36	EH7148H
 FS-2S	19 mm	4-0	○	45	SLIMMED	36	R633H
 FS-1	24 mm	3-0	●	45		36	EH7684H
		3-0	○	45		36	R647H
		2-0	●	45		36	EH7683H
 FS	26 mm	2-0	○	45		36	R665H
 FSL	30 mm	2-0	●	75		36	EH7638H
		2-0	○	45		36	R677H
		0	●	75		36	EH7637H

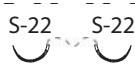
▼ 3/8 Circle MICROPPOINT* Spatula							
Needle	Gauge	Suture Color	Length (cm)	Other information	Number per box	Code	
 TG140-6	6,5 mm	10-0	●	30	MONOFILAMENT	12	W1775

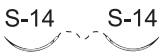
▼ 1/2 Circle Spatula Needles							
Needle	Gauge	Suture Color	Length (cm)	Other information	Number per box	Code	
 S-22	8 mm	5-0	○	45		12	1765G

1/4 Circle Spatula Needles						
Needle	Gauge	Suture Color	Length (cm)	Other information	Number per box	Code
 S-14	8 mm	6-0	45		12	1722G
		5-0	45		12	1760G
 RD-1	8 mm	5-0	45	CENTER POINT SPATULA	12	746G

1/4 Circle Conventional Spatula Needles						
Needle	Gauge	Suture Color	Length (cm)	Other information	Number per box	Code
 S-4	8 mm	4-0	45		12	1778G

Ligatures						
	Gauge	Suture Color	Length (cm)	Other information	Number per box	Code
SUTUPAK*	5-0	●	140		36	EH6411H
	3-0	●	140		36	EH6413H
	2-0	●	140		36	EH6414H
	0	●	140		36	EH6415H
	1	●	140		36	EH6416H
	2	●	140		36	EH6417H
	3	●	140		36	EH6418H
SUTUPAK*	2-0	●	2x70		36	EH6884H
	0	●	2x70		36	EH6885H
	1	●	2x70		36	EH6886H
	2	●	2x70		36	EH6887H
SUTUPAK*	3-0	●	3x45		36	EH6853H
	0	●	3x45		36	EH6855H
	1	●	3x45		36	EH6856H
	2	●	3x45		36	EH6857H
	3	●	3x45		36	EH6858H
SUTUPAK*	1	●	6x45		36	EH6736H
SUTUPAK*	3-0	●	12x45		36	EH6663H
	1	●	12x45		24	EH6666E

NUROLON*

(Polyamide 6/6) Suture



ETHICON
PART OF THE *Johnson & Johnson* FAMILY OF COMPANIES

SUTURE

Description: Braided For easy handling and secure knot tying.
Coated For easy passage through tissue.
Synthetic For minimal tissue reaction.
Non-absorbable Provides prolonged tensile strength retention in tissue.

Color: Black.

Range: 5-0 to 1 (USP). Supplied as needed sutures or ligatures.

Indications: NUROLON* sutures are intended for use in general soft tissue approximation and/or ligation, including use in cardiovascular, ophthalmic and neurosurgical procedures. Typical areas of use include:

- Drain fixation
- Ligation

Full details in the Instruction for Use included in every package.



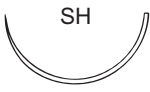
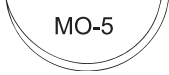

1/2 Circle Taper Point Needles

Needle	Gauge	Suture Color	Length (cm)	Other information	Number per box	Code
 SH 26 mm	3-0	●	75		36	NL832H
	2-0	●	75		36	NL833H
 MO-5 31 mm	1	●	75		12	W5723

1/2 Circle TAPERCUT* Needles

Needle	Gauge	Suture Color	Length (cm)	Other information	Number per box	Code
 V-37 40 mm	1	●	100		12	W5415

3/8 Circle Reverse Cutting Needles

Needle	Gauge	Suture Color	Length (cm)	Other information	Number per box	Code
 FS-2 19 mm	4-0	●	45		36	NL7616H
 FS 26 mm	3-0	●	75		36	NL7615H
	2-0	●	75		36	NL7614H
 FSLX 36 mm	2-0	●	75		36	5642H

Ligatures

	Gauge	Suture Color	Length (cm)	Other information	Number per box	Code
SUTUPAK*	2-0	●	2x70		36	EH6584H
SUTUPAK*	2-0	●	3x45		36	EH6604H
	0	●	3x45		36	EH6605H
	1	●	3x45		36	EH6606H
SUTUPAK*	2-0	●	10x75		12	W5223
	1	●	10X75		12	W5225
SUTUPAK*	4-0	●	12x45		36	EH6621H
	3-0	●	12x45		36	EH6622H
	2-0	●	12X45		36	EH6623H
SUTUPAK*	0	●	17x45		12	W5204

SILK

Suture

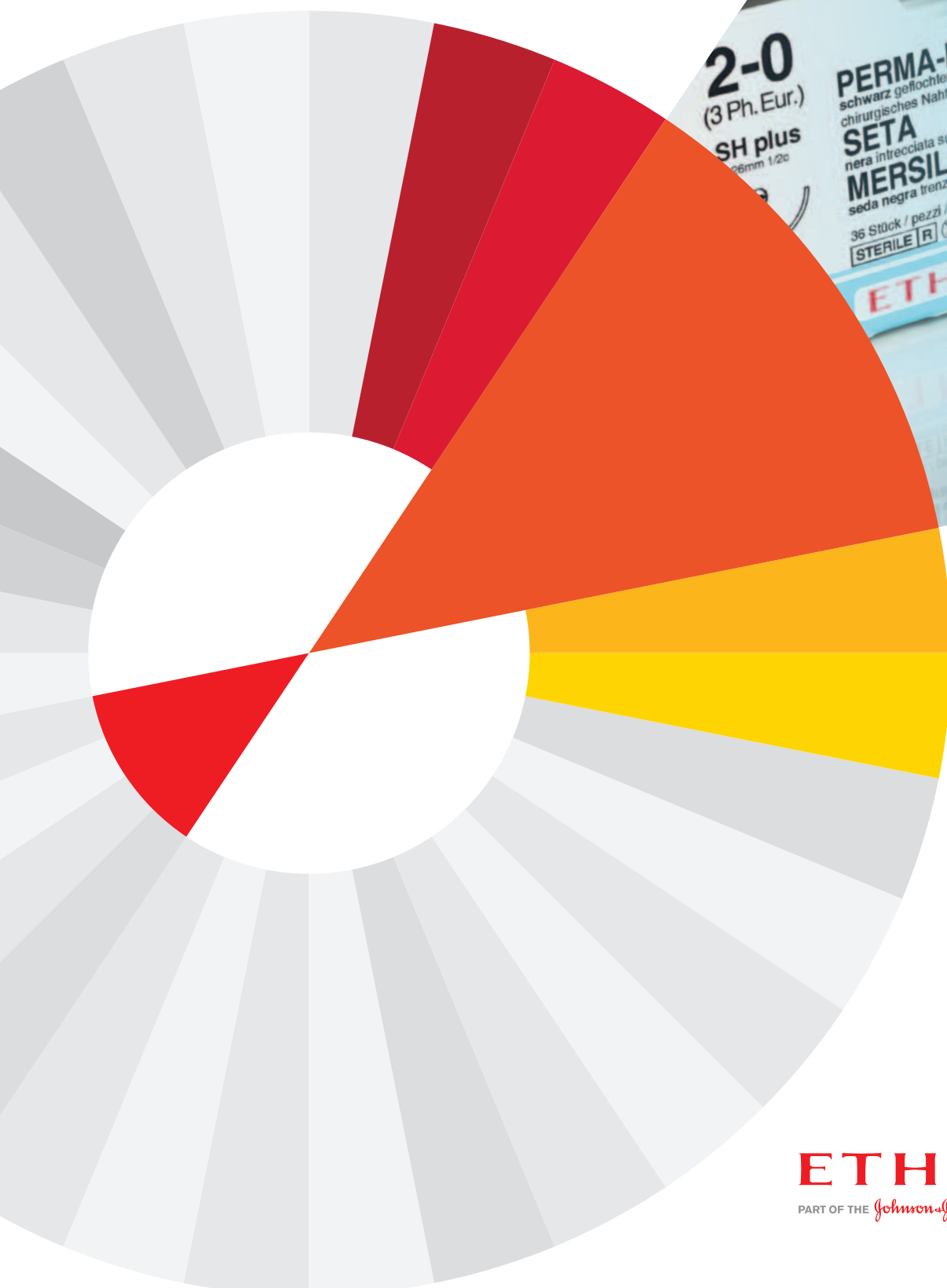

ETHICON

PART OF THE *Johnson & Johnson* FAMILY OF COMPANIES

SILK

Braided Silk / Virgin silk

SUTURE

Description:

Braided	For easy handling and secure knot tying.
Coated	With wax for easy handling.
Natural	Produced from cocoons of the silk worm <i>Bombyx Mori</i> .
Non-absorbable	Provides prolonged tensile strength retention in tissue for up to 3 months.

Color:

Black or white.

Range:

10-0 to 4 (USP). Supplied as needed sutures or ligatures. Sizes 10-0 to 8-0 are manufactured of virgin silk and are twisted in construction. Virgin silk fibres are held together by natural gum secreted by the silk worm.





Indications:



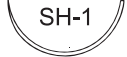
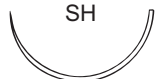

SILK sutures are intended for use in general soft tissue approximation and/or ligation, including use in cardiovascular, ophthalmic and neurosurgical procedures. Typical areas of use include:

- Ophthalmic surgery
- Dental surgery
- Ligation

Full details in the Instruction for Use included in every package.





1/2 Circle Taper Point Needles							
Needle	Gauge	Suture Color	Length (cm)	Other information	Number per box	Code	
 TF 13 mm	5-0	●	45		36	N266H	
	4-0	●	45		36	N267H	
 RB-1 17 mm	5-0	●	75		36	K870H	
	4-0	●	75		36	K871H	
	3-0	●	75		36	K872H	
	2-0	●	75		36	K873H	
 SH-1 22 mm	3-0	●	75		36	EH7343H	
	2-0	●	75		36	EH7344H	
 SH 26 mm	4-0	●	75		36	K831H	
	3-0	●	75		36	K832H	
	2-0	●	75		36	K833H	
	0	●	75		36	K834H	
	1	●	75		36	K835H	
 MH 36 mm	2-0	●	75		36	K843H	
	0	●	75		36	K844H	
	1	●	75		36	K845H	
	2	●	75		36	K846H	

3/8 Circle Taper Point Needles							
Needle	Gauge	Suture Color	Length (cm)	Other information	Number per box	Code	
 BV-1 9,3 mm	7-0	●	30		36	K803H	
 C-1 13 mm	6-0	●	75		36	K889H	
	5-0	●	75		36	K890H	
	4-0	●	75		36	K891H	
 C-1 C-1 13 mm	6-0	●	45		36	706H	
 BB 17 mm	4-0	●	75		36	K881H	





Straight Taper Point Needles							
Needle	Gauge	Suture Color	Length (cm)	Other information	Number per box	Code	
 ST-4 19 mm	4-0	●	45		12	18507G	
	4-0	●	75		36	K861H	





SILK

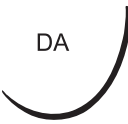

Braided Silk / Virgin silk



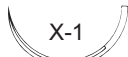



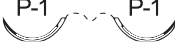

1/2 Circle TAPERCUT* Needles						
Needle	Gauge	Suture Color	Length (cm)	Other information	Number per box	Code
 V-5 17 mm	4-0	●	75		36	K952H
	3-0	●	45		12	18514G
	3-0	●	75		36	K953H
 V-7 26 mm	3-0	●	75		12	K963G
	2-0	●	75		36	K964H

3/8 Circle TAPERCUT* Needles						
Needle	Gauge	Suture Color	Length (cm)	Other information	Number per box	Code
 V-4 17 mm	4-0	●	75		36	K942H
	3-0	●	75		36	K943H

Compound Curve TAPERCUT* Needles						
Needle	Gauge	Suture Color	Length (cm)	Other information	Number per box	Code
 DA-1  VISI-BLACK 13 mm	4-0	●	45	VISI-BLACK*	12	18534G
 DA  VISI-BLACK 25 mm	4-0	●	45	VISI-BLACK*	12	18529G

1/2 Circle Reverse Cutting Needles						
Needle	Gauge	Suture Color	Length (cm)	Other information	Number per box	Code
 M-1 13 mm	5-0	●	45		36	688H
 J-1 17 mm	4-0	●	45		12	18501G
	4-0	●	45		36	734H
 X-1 22 mm	3-0	●	45		12	18502G
	3-0	●	45		36	632H
	2-0	●	45		36	737H
 CP-1 36 mm	2-0	●	75		36	443H



▼ 3/8 Circle Reverse Cutting PRIME* Needles						
Needle	Gauge	Suture Color	Length (cm)	Other information	Number per box	Code
 P-1 11 mm	6-0	●	45		36	639H
	6-0	●	45		12	786G
 P-1 11 mm	6-0	●	45		12	780G
 P-3 13 mm	5-0	●	45		36	640H
	4-0	●	45		12	18508G



▼ 3/8 Circle Reverse Cutting Needles						
Needle	Gauge	Suture Color	Length (cm)	Other information	Number per box	Code
 C-3 13 mm	5-0	●	45		36	719H
	4-0	●	45		36	736H
	4-0	●	45		12	W811
 C-3 13 mm	4-0	●	30		36	735H
	4-0	○	45		12	W816
 M-2 13 mm	4-0	●	45		36	739H
 FS-3 16 mm	6-0	●	45		36	681H
 FS-2 19 mm	5-0	●	45		36	682H
	4-0	●	45		12	EH7149G
	3-0	●	45		36	EH7345H
 FS-1 24 mm	4-0	●	45		36	629H
	3-0	●	45		36	684H
 FS 26 mm	2-0	●	45		36	685H
 FSL 30 mm	2-0	●	45		36	677H
	2-0	●	75		36	679H
	0	●	75		36	680H
 FSLX 36 mm	0	●	75		36	EH7560H



▲ 3/8 Circle Conventional Cutting PRIME* Needles						
Needle	Gauge	Suture Color	Length (cm)	Other information	Number per box	Code
 PC-3 16 mm	6-0	●	45		36	W529H
	5-0	●	45		36	W528H
	4-0	●	45		12	W604

SILK

Braided Silk / Virgin silk

▼ 3/8 Circle MICROPOINT* Reverse Cutting Needles							
Needle	Gauge	Suture Color	Length (cm)	Other information	Number per box	Code	
 G-6	8 mm	7-0	●	30		12	EH7464G
		6-0	●	30		12	EH7435G
 G-6	8 mm	7-0	●	45		12	768G
		6-0	●	45		12	769G
 G-3	13 mm	4-0	●	45		12	783G

▼ 1/2 Circle MICROPOINT* Reverse Cutting Needles							
Needle	Gauge	Suture Color	Length (cm)	Other information	Number per box	Code	
 G-7	8 mm	8-0	●	45		12	W870
 G-7	8 mm	8-0	●	45		12	W818

▼ 3/8 Circle MICROPOINT* Spatula							
Needle	Gauge	Suture Color	Length (cm)	Other information	Number per box	Code	
 TG140-6	6,5 mm	8-0	●	30		12	W1782
 TG140-8	6,5 mm	8-0	●	45		12	W1819

▼ 1/4 Circle Spatula Needles							
Needle	Gauge	Suture Color	Length (cm)	Other information	Number per box	Code	
 S-14	8 mm	6-0	●	45		12	1780G
		5-0	●	45		12	EH7440G

Ligatures						
	Gauge	Suture Color	Length (cm)	Other information	Number per box	Code
LIGAPAK*	4-0	●	250	Reel	20	F4202
SUTUPAK*	2-0	●	140		36	EH6804H
	1	●	140		36	EH6806H
	2	●	140		36	EH6807H
SUTUPAK*	3-0	●	2x70		36	EH6833H
	0	●	2x70		24	EH6835E
	1	●	2x70		24	EH6836E
	2	●	2x70		24	EH6837E
SUTUPAK*	4-0	●	3x45		36	EH6762H
	3-0	●	3x45		36	EH6763H
	2-0	●	3x45		36	EH6764H
	0	●	3x45		36	EH6765H
	2	●	3x45		36	EH6767H
	3	●	3x45		36	EH6768H
SUTUPAK*	3-0	●	5x70		36	EH6823H
	2-0	●	5x70		36	EH6824H
	0	●	5x70		36	EH6825H
SUTUPAK*	2-0	●	10x75		12	W223
	1	●	10x75		12	W225
SUTUPAK*	4-0	●	12x45		24	EH6722E
	3-0	●	12x45		24	EH6723E
	2-0	●	12x45		36	EH6724H
SUTUPAK*	4-0	●	13x60		12	W211

STEEL

Suture



ETHICON
PART OF THE *Johnson & Johnson* FAMILY OF COMPANIES

STEEL

Monofilament and Multifilament

SUTURE

Description:

Multifilament or monofilament.

Non-absorbable Provides permanent tensile strength retention in tissue.

Color:

Undyed.

Range:

5-0 to 7 (USP). Supplied as needled sutures and ligatures. Also available as pull-out tendon suture with barb.

Indications:



STEEL sutures are intended for use in abdominal wall closure, hernia repair, sternal closure and orthopedic procedures including cerclage and tendon repair.



Typical areas of use include:





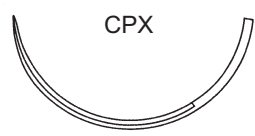

- Closure of sternum
- Pull-out tendon repair with the Bunnell technique

Full details in the Instruction for Use included in every package.



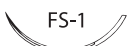

1/2 Circle TAPERCUT* Needles							
Needle	Gauge	Suture Color	Length (cm)	Other information	Number per box	Code	
 V-37	40 mm	1	●	4x45	Monofilament	12	M660G
 V-40	48 mm	4	●	4x45	Monofilament	12	M651G
		6	●	6x45	Monofilament	12	6OF8348G
		6	●	4X45	Monofilament	12	M649G

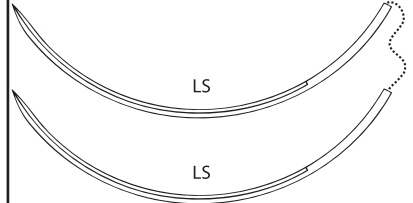
1/2 Circle Reverse Cutting Needles (Heavier Wire Diameter)							
Needle	Gauge	Suture Color	Length (cm)	Other information	Number per box	Code	
 CPX	48 mm	5	●	45	Monofilament	12	EH7677G
		7	●	4x45	Monofilament	12	M624G
 CPXX	55 mm	5	●	6x45	Monofilament.	12	MEH7216G
		5	●	2x75	Monofilament	12	W902

3/8 Circle Reverse Cutting Needles							
Needle	Gauge	Suture Color	Length (cm)	Other information	Number per box	Code	
 FS-2	19 mm	3-0	●	75	Monofilament	12	F2707
 FS-2S	19 mm	4-0	●	45	Monofilament, slimmed	36	603H
 FS-1	24 mm	3-0	●	45	Multifilament	36	EH7602H
 FSL	30 mm	2-0	●	45	Multifilament	36	EH7603H
 FSLX	36 mm	2-0	●	45	Multifilament	36	FO8444H
 LS-1	45 mm	2	●	60	Monofilament	12	400G
 LS	90 mm	2	●	90	Multifilament	6	EH7611

STEEL

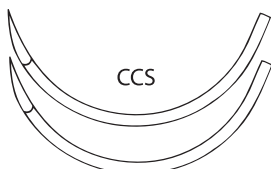
Monofilament and Multifilament

▲ 1/2 Circle Conventional Cutting Needles (Heavier Wire Diameter)							
Needle	Gauge	Suture Color	Length (cm)	Other information	Number per box	Code	
 CCS	48 mm	5	●	4x45	Monofilament	12	MEH7210G
		5	●	6x45	Monofilament	12	MEH7212G
		6	●	4x45	Monofilament	12	653BG
		6	●	6x45	Monofilament	12	MEH7213G
		7	●	4x45	Monofilament	12	MEH7211G
 CCS	48 mm	5	●	75	Monofilament	12	OMM8378G
 CCS-1	60 mm	5	●	2x75	Monofilament	12	M436C

Special Combinations						
Needle	Gauge	Suture Color	Length (cm)	Other information	Number per box	Code
	2-0	●	35	Double-armed suture with straight needles and a looped suture with the curved needle. Multifilament. With polypropylene button.	12	EH7627G
	3-0	●	20	Double-armed suture with straight needles and a looped suture with the curved needle. Multifilament. With polypropylene button.	12	EH7623G
	2-0	●	30	Multifilament. Pull-out tendon suture with barb.	12	SN13G
	2-0	●	30	Multifilament. Pull-out tendon suture with barb.	12	SN1G
	3-0	●	40	Multifilament. Pull-out tendon suture with barb.	12	SN17G
	4-0	●	20	Double-armed suture with straight needles and a looped suture with the curved needle. Multifilament.	12	554G

Ligatures						
	Gauge	Suture Color	Length (cm)	Other information	Number per box	Code
	2-0		6x45	Monofilament	40	F6714



Hernia Solutions

A brief time in surgery -
a lifetime impact on your patient



ETHICON
PART OF THE *Johnson & Johnson* FAMILY OF COMPANIES

Introduction

Hernia surgery places particular demands on the properties of surgical suture material and implants. We are undertaking intensive research and development work to meet the challenges presented in this area. The dialogue with our customers is a regular source of product innovations such as our range of MPPAM Macroporous, partially absorbable light-weight surgical meshes and a wide range of synthetic, absorbable threads. As an innovative manufacturer of surgical suture material and implants, we are investing daily on a global basis, developing our products to meet operating requirements by applying our exemplary standards of quality and consistently wide-ranging, individualised services.



Ethicon utilises more than 120 years of experience to provide you with the support you need for your work.

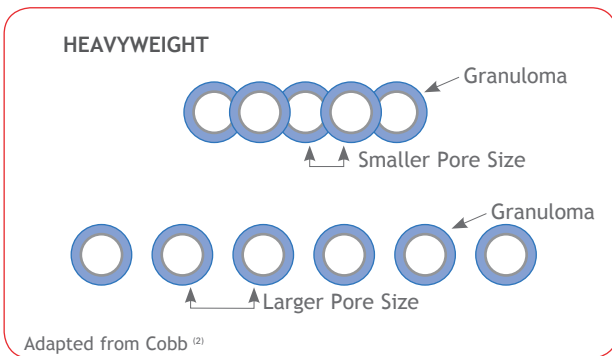

Reference: COBB WS, KERCHER KW, HENIFORD BT. The argument for lightweight polypropylene mesh in hernia repair. SURG INNOV. 2005

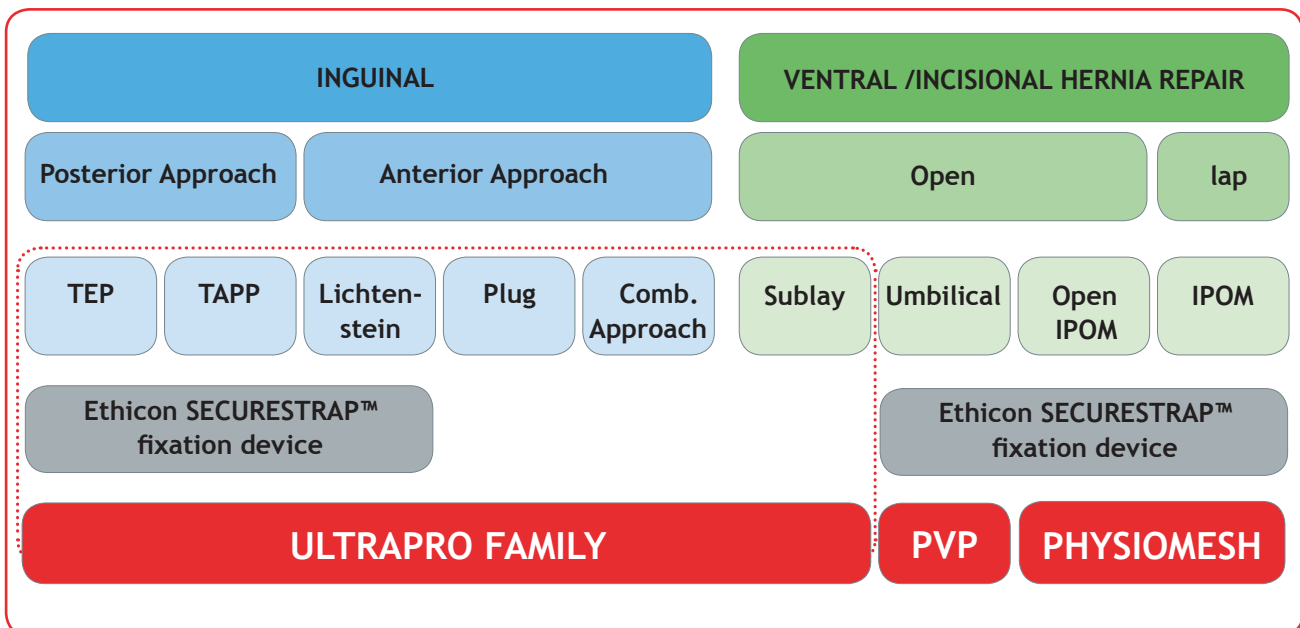

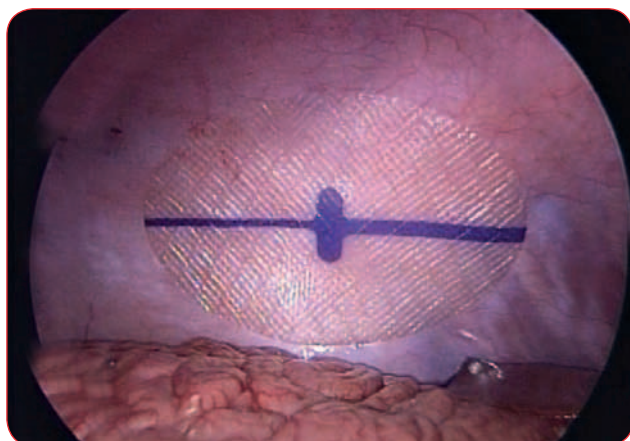
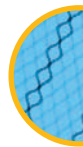

PHYSIOMESH™ Flexible composite mesh

Tissue-separating mesh.

Macroporous and partially absorbable lightweight.

For open and laparoscopic ventral/ incisional hernia repair.

Clings to the abdominal wall to ease placement

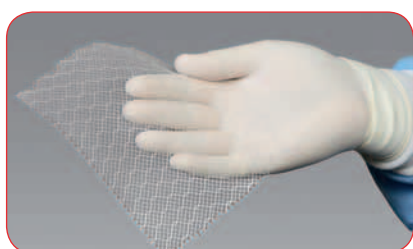

Transparent and trimmable. Absorbable markers for orientation. Can be placed with either side towards viscera



Easy to roll, sufficient memory for ease of deployment

Combines exceptional handling with comfort and security for your patients

Most proven mesh before launch in 2010

16 preclinical studies

Properties:

Prolene™ macroporous 3mm, thin filament mesh, allows for excellent parietal tissue integration and provides a flexible scar mesh. Shrink about 10%.

ref: J-L Holste DVM; T Muench, DVM; P Shnoda, DVM; S Wohlert, PHD; L Mcroy, MD Ethicon Inc., Somerville, New Jersey

The MONOCRYL film is an effective tissue separating barrier-minimizes visceral attachments thus reducing the risk for complications and patient discomfort. It's partially absorbable and leaving a mesh which is compliant with the abdominal wall, promoting comfort and mobility.

Dimensions	Packaging	Product Code
7 cm x 15cm rectangular shape	1 per box	PHY715R
10 x 15cm oval shape	1 per box	PHY1015V
15 x 15cm square shape	1 per box	PHY1515Q
15 x 20cm rectangular shape	1 per box	PHY1520R
15 x 20 cm oval shape	1 per box	PHY1520V
20 x 25 cm oval shape	1 per box	PHY2025V
20 x 30cm rectangular shape	1 per box	PHY2030R
25 x 35cm oval shape	1 per box	PHY2535V
30 x 35cm rectangular shape	1 per box	PHY3035R
30 x 50cm rectangular shape	1 per box	PHY3050R



PROCEED™ Surgical Mesh Tissue-separating mesh

Strong, macroporous and partially absorbable lightweight.

For open and laparoscopic ventral hernia repair.



Permanent thin light polypropylene mesh

Combines good handling with comfort and security for your patients.

Clinically proven to give feasible results with very low complication rates and was found to offer technical advantages considering mesh handling.

(Berrevoet et al, Hernia 2009. Rosenberg et al. Hernia 2008.)

Properties:

- **PROLENE™ Soft** - Macroporous, lighter-weight mesh for strong tissue integration and a natural healing process.
- **Bioresorbable Oxidized Regenerated Cellulose (ORC)** - Minimizes tissue attachment.
- **Absorbable polydioxanone (PDS)** - Bonds the ORC to the mesh.

	Dimensions	Packaging	Product Code
	5 X 10 CM RECTANGULAR	1 per box	PCDB1
7.5 X 15 CM RECTANGULAR	1 per box	PCDR1	
10 X 15 CM OVAL	1 per box	PCDN1	
15 X 15 CM SQUARE	1 per box	PCDM1	
10 X 20 CM RECTANGULAR	1 per box	PCDD1	
15 X 20 CM OVAL	1 per box	PCDG1	
20 X 25 CM OVAL	1 per box	PCDH1	
20 X 30 CM RECTANGULAR	1 per box	PCDJ1	
26 X 34 CM OVAL	1 per box	PCDT1	
25 X 35.5 CM RECTANGULAR	1 per box	PCDW1	
30.5 X 30.5 CM SQUARE	1 per box	PCDL1	

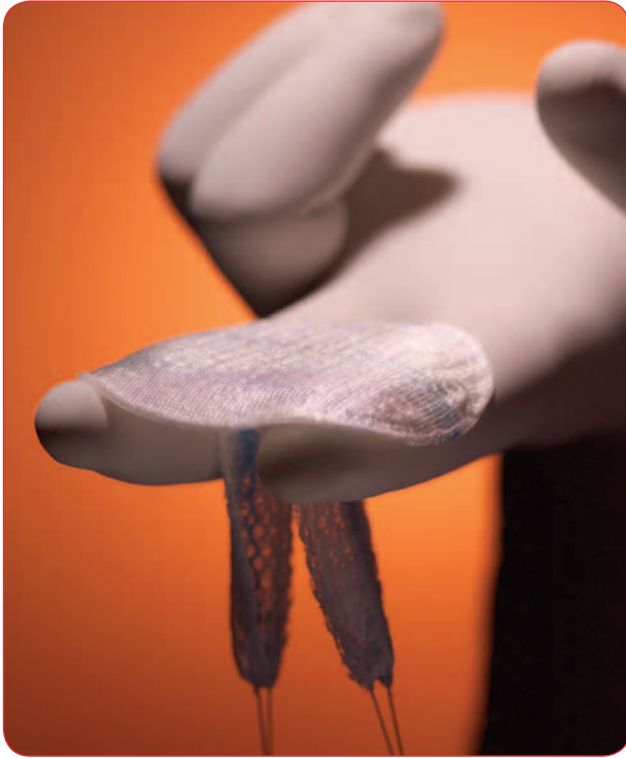

PROCEED™ Ventral Patch - PVP™

For open hernia repair IPOM

Macroporous and partially absorbable tissue-separating device.

For comfortable healing of umbilical hernias and other fascial deficiencies.

Allows your patients to heal naturally without compromising on strength

Builds on PROCEED™ Surgical Mesh technology.

Unique design contours with the body for secure placement and stable positioning.

Macroporous, lighter-weight mesh for strong tissue integration and a natural healing process.

Partially Absorbable technology leaving minimal amount of permanent foreign material.

No ePTFE.

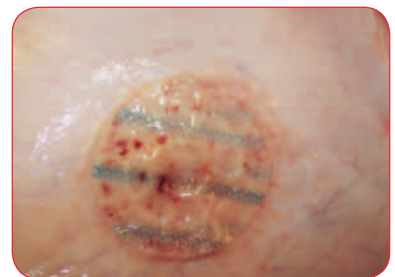

PVP™ upon deployment

PVP™ at 14 days

	Dimensions		Packaging	Product Code
	4.3 cm x 4.3 cm		2 per box	PVPS
	6.4 cm x 6.4 cm		2 per box	PVPM

ETHICON SECURESTRAP™

5mm Absorbable strap fixation device. For fixation of prosthetic material to soft tissues in various laparoscopic and open surgical procedures, such as Hernia Repair.

Unique design delivers secure and consistent fixation for as long as you need it also in various angles then absorbs - leaving less implanted foreign material.

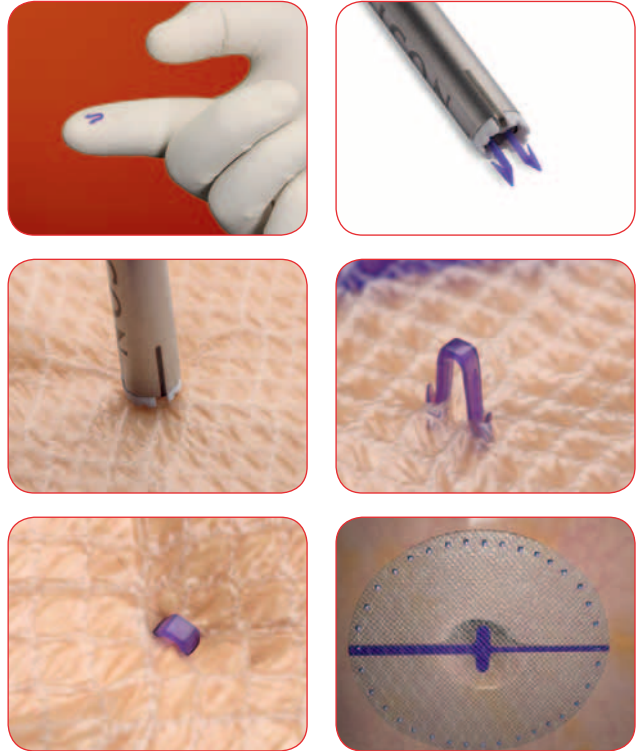

Consistent Strap Deployment

When the trigger is depressed a spring inside the handle is compressed. At full stroke, the spring is released, deploying the strap with the same consistency - reducing user variability.



Absorbable Dyed Straps

Synthetic absorbable straps dyed purple for clear visibility in the abdominal cavity. Minimal absorption in the first two weeks post implantation delivers secure mesh fixation during the tissue integration period. Degradation by hydrolysis significant after the critical tissue integration period has occurred and the polymer absorption is essentially complete at approx. 12 months.

Ref: Prediction of In Vivo Total Absorption Time for ORION Implant Using In Vitro/In Vivo Correlation Degradation Model (AST-2009-0332)

Dimensions	Packaging	Product Code
5mm singel use device with 25 absorbable STRAPS	6 device per box	STRAP25
5mm singel use device with 25 absorbable STRAPS	1 device per box	STRAP25R
5mm singel use device with 12 absorbable STRAPS	6 device per box	STRAP12



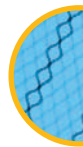

ULTRAPRO™ Mesh

Macroporous partially absorbable and lightweight for natural abdominal wall function

- For lap. Inguinal hernia repair
- For open inguinal/lichtenstein
- For open incisional/ventral hernia repair

Unique combination

Made up of equal parts of non-absorbable polypropylene fibres (PROLENE™) and absorbable polyglactone fibres (MONOCRYL), giving this the properties of large-pore mesh(3-4mm) MONOCRYL fibres reinforce the mesh making it easier to position. MONOCRYL is absorbed within 90 - 120 days.

Light-weight PROLENE™ Mesh remains in the body. Formation of a flexible collagen fibre network instead of a rigid scar formation.

Life-long safety

Low recurrence rate due to permanent stabilisation ULTRAPRO Mesh exhibits extremely low shrinkage (average 1.9 %) and is therefore extremely suited to hernia repair (Heniford surg. INNO 205)

(Köckerling surg endosc.2007)

A lifetime of comfort for your patients

Macroporous partially absorbable lightweight meshes are clinically proven to cause less pain and discomfort than heavyweight meshes.

(Bringman et al. BJoS 2006)

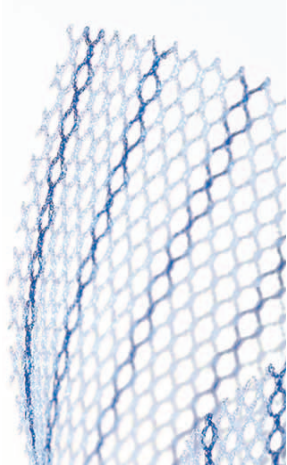
	Dimensions	Packaging	Product Code
	10 X 12 CM	3 per box	UMP3
	7.5 X 15 CM	3 per box	UMR3
	10 X 15 CM	3 per box	UMN3
	15 X 15 CM	3 per box	UMM3
	15 X 30 CM	1 per box	UMT1
	30 X 30 CM	1 per box	UML1

ULTRAPRO™ Hernia System, UHS

Macroporous partially absorbable and light weight for natural abdominal wall function.
For open inguinal hernia repair.

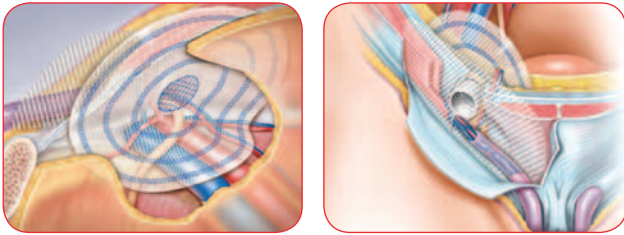

UHS Posterior and Anterior view

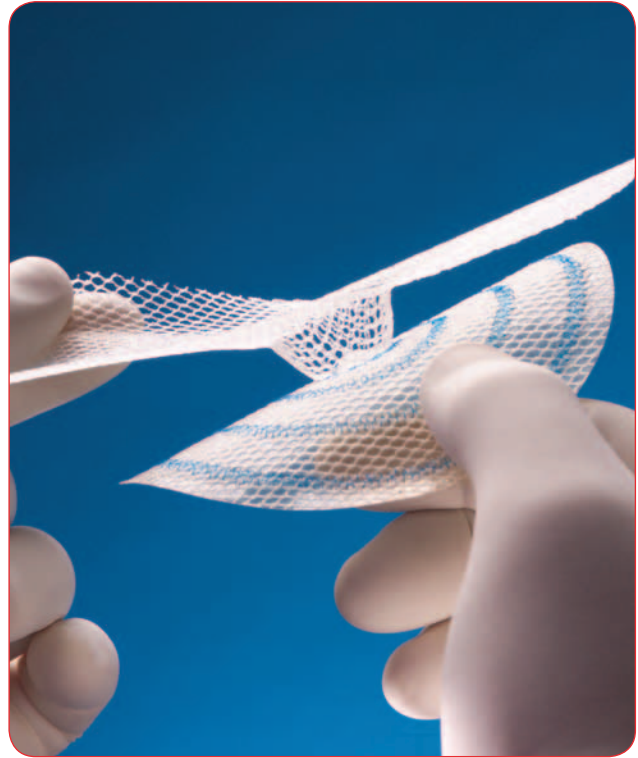

3-In-1 device for the combined anterior & posterior open repair of groin hernias

- Onlay patch covers the inguinal canal floor.
- Connector - secures the underlay which virtually eliminates migration.
- Underlay - provides posterior support. MONOCRYL film allows consistent, wrinkle-free deployment.

Clinical data shows:

In conclusion, this study demonstrated that hernia surgery with 3D partly resorbable meshes is associated with low rates of recurrence and chronic pain. The rate of satisfied patients is high

A. Koch, R. Lorenz, M. Wiese, H. Lippert for the working group Quality Assurance in day case hernia surgery in collaboration with the Quality institute for operative medicine, University of Magdeburg

	Dimensions	Packaging	Product Code
	Onlay Patch Underlay Patch	width: 6 cm length: 12 cm diameter: 7,5 cm	3 per box UHSM Medium
	Onlay Patch Underlay Patch	width: 6 cm length: 12 cm diameter: ~10 cm	3 per box UHSL Large
	Onlay Patch Underlay Patch	width: 6 cm length: 12 cm width: ~10 cm length: 12cm	3 per box UHSOV Oval

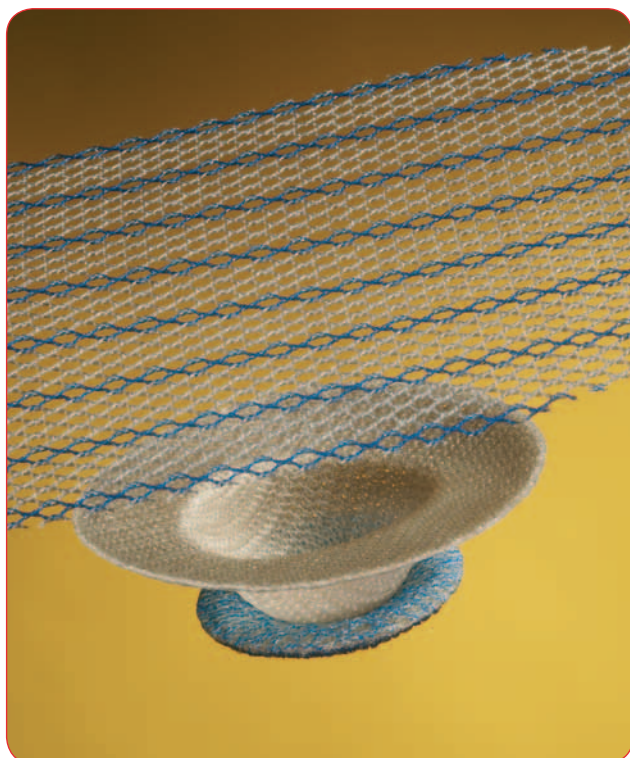

ULTRAPRO™ Plug, UPP

Macroporous partially absorbable, and lightweight for natural abdominal wall function

Next generation plug & patch

- Easy to use, familiar technique.
- Lightweight and partially absorbable.
- Secure repair.

A novel design

- Large onlay patch provides coverage of entire inguinal floor.
- Rim provides an intuitive platform for fixation.
- Body fills the defect with tapered 3-D mesh.
- Anchor designed to provide stability in the defect and minimize risk of migration.



Dimensions	Packaging	Product Code
Onlay Patch Plug 12 * 7,5 cm Rim diameter: 5 cm Anchor diameter: 3 cm	2 per box	UPPS2 Small
Onlay Patch Plug 12 * 7,5 cm Rim diameter: 5 cm Anchor diameter: 4 cm	2 per box	UPPM2 Medium
Onlay Patch Plug 12 * 7,5 cm Rim diameter: 5 cm Anchor diameter: 5 cm	2 per box	UPPL2 Large



VYPRO™ II Mesh

Macroporous partially absorbable and multifilament lightweight mesh for open ventral and inguinal hernia repair

PROLENE™

non-absorbable polypropylene

VICRYL™

absorbable polyglactin

- Long-lasting mutual integration achieved with improved connective scar tissue formation compared to small pore meshes.
- Partially absorbable macroporous lightweight meshes are clinically proven to cause less pain and discomfort than heavyweight meshes (*Bringman et al. BJoS 2006*)
- Pore size 3-4mm

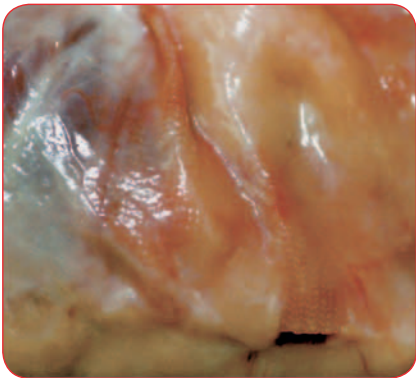

Traditional polypropylene mesh. 90 days post-implantation. Fold development (in-vivo study)

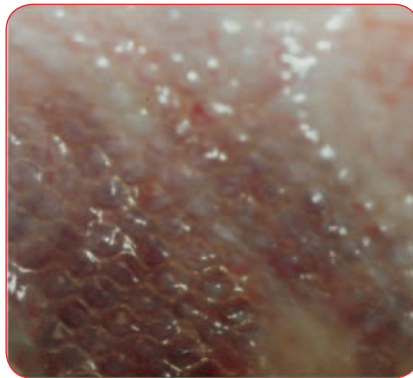

Lightweight VYPRO* II mesh. 90 days post-implantation. Fold-free incorporation (in-vivo study)

	Dimensions	Packaging	Product Code
	12cm x 10cm	3 per box	PVM2P3
	15cm x 10cm	3 per box	PVM2N3
	15cm x 15cm	3 per box	PVM2M3



VYPRO™ Mesh

Macroporous partially absorbable multifilament lightweight mesh for open ventral hernia repair

PROLENE™
non-absorbable polypropylene

VICRYL™
absorbable polyglactin

VYPRO™
mesh is placed preperitoneally as a sublay.
Pore size 4-5mm

- Direct contact between the mesh and intraperitoneal structures must be avoided by intact peritoneum.

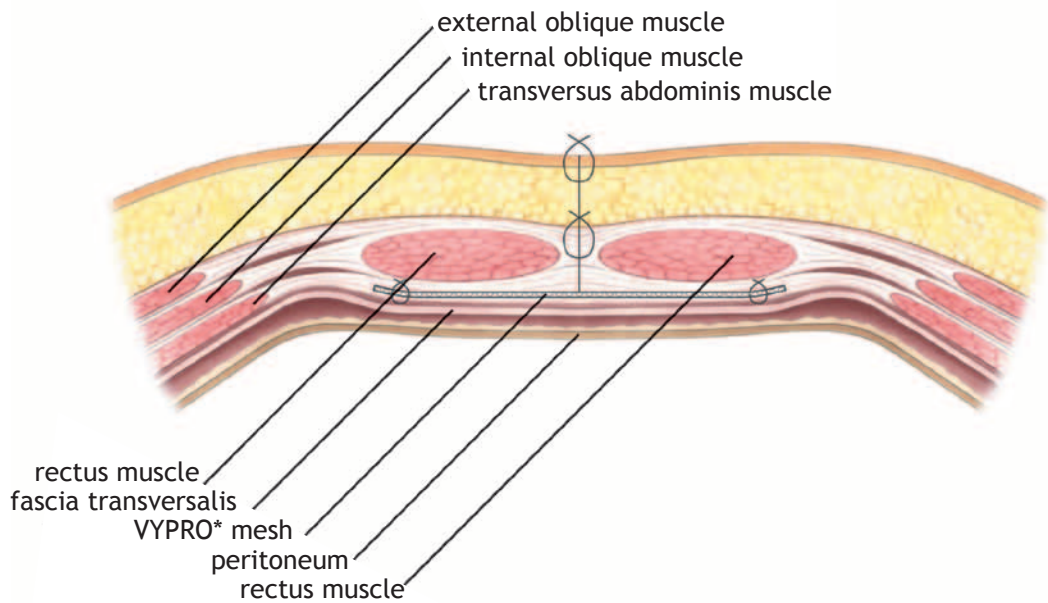

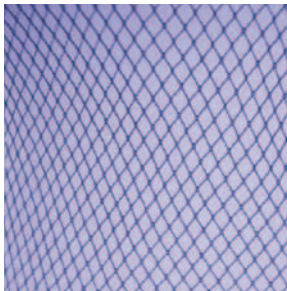
	Dimensions	Packaging	Product Code
	15 X 10 CM UNDYED	1 per box	PVMN1
	15 X 15 CM UNDYED	1 per box	PVMM1
	30 X 30 CM UNDYED	1 per box	PVML1



PROLENE™ Mesh

Polypropylene mesh

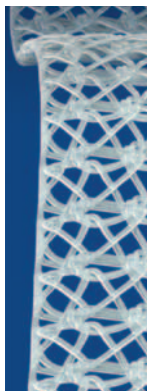

Dimensions	Packaging	Product Code
12 X 10 CM	3 per box	PMP3
15 X 7.5 CM	3 per box	PMR3
15 X 10 CM	3 per box	PMN3
15 X 15 CM	3 per box	PMM3
30 X 30 CM	1 per box	PML1

VICRYL™ Mesh

Absorbable polyglactin mesh
for temporary tissue support

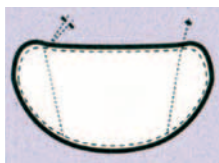

VM102 18 X 10 CM
Renal prosthesis

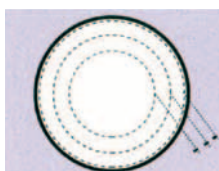

VM106 26 X 30 CM
Splenic prosthesis

Dimensions	Packaging	Product Code
6 X 5 CM	3 per box	VM605
8 X 2 CM	1 per box	VM802
12 X 8 CM	3 per box	VM1208
15 X 8 CM	1 per box	VM101
25 X 15 CM	3 per box	VM2515
30 X 20 CM	3 per box	VM3020
18 X 10 CM Renal prosthesis	1 per box	VM102
26 X 30 CM Splenic prosthesis	1 per box	VM106

MERSILENE™ Mesh

Polyester mesh



Dimensions	Packaging	Product Code
30 X 15 CM	1 per box	RM3015
30 X 30 CM	1 per box	RM3030
50 X 30 CM	1 per box	TS55



PROLENE™ Hernia System

3-In-1 device for the combined anterior & posterior open repair of groin hernias

Innovative three-in-one design

1. Onlay Patch

Provides a patch for the floor of the inguinal canal providing the security of conventional mesh repair techniques.

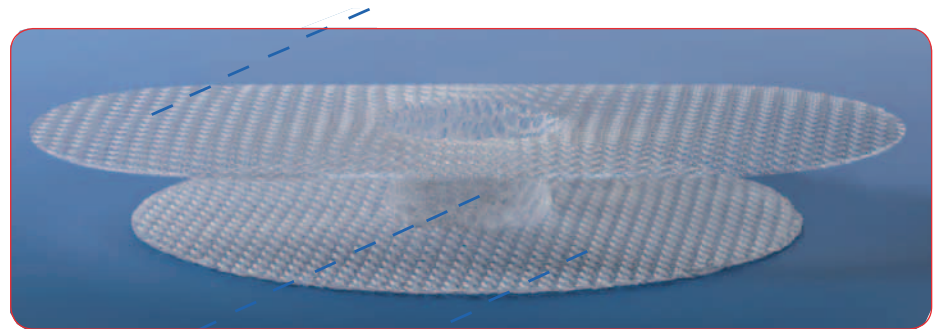

2. Connector

Sits in internal ring or defect. Secures overlay patch to underlay for security.

3. Underlay Patch

Should be deployed, pre-peritoneally, after insertion to provide a posterior repair.



Dimensions		Packaging	Product Code
Onlay Patch	width: 4,5 cm length: 10 cm	1 per box	PHSM1 Medium
Connector	diameter: 1,91 cm height: 1,27 cm		
Underlay Patch	diameter 7,5 cm		
Onlay Patch	width: 4,5 cm length: 10 cm	1 per box	PHSL1 Large
Connector	diameter: 1,91 cm height: 1,27 cm		
Underlay Patch	diameter 10 cm		
Onlay Patch	width: 5,5 cm length: 12,5 cm	1 per box	PHSE1 extended
Connector	diameter: 1,91 cm height: 1,27 cm		
Underlay Patch	diameter: 10 cm		

All three sizes are packed in flat, easy-to-store boxes with patient tracking labels.



ETHICON Hernia Solutions

One source for all your surgical needs



PHYSIOMESH™

Flexible composite mesh- MPPAM macro porous partially absorbable mesh. Tissue separating mesh for open and laparoscopic ventral/incisional hernia repair.



PROCEED™

Tissue separating and MPPAM*. For open & laparoscopic Ventral/incisional hernia repair.



PVP™

Tissue separating and MPPAM*. For open repair of umbilical hernias or other fascial defects.



ETHICON SECURESTRAP™

5mm Absorbable strap fixation device. For fixation of prosthetic material to soft tissues in various laparoscopic and open surgical procedures, such as hernia repairs.



ULTRAPRO™ Mesh

MPPAM*. Pore size 3-4mm. Monofilament mesh for abdominal wall reinforcement. For open and lap. ventral/incisional and inguinal hernia repair.



ULTRAPRO™ Hernia System, UHS

MPPAM*. 3-in-1 device for the combined anterior & posterior open repair of groin hernias.



ULTRAPRO™ Plug

A novel plug & patch design in MPPAM. For openinguinal hernia repair.



VYPRO™ II

MPPAM*. Pore size 3-4mm Multifilament mesh for open and laparoscopic inguinal hernia repair.



VYPRO™

MPPAM pore size 5mm. Multifilament mesh for open incisional hernia repair.



PROLENE™

Monofilament polypropylene mesh for the repair of abdominal wall fascial defects.



PROLENE™ Hernia System, PHS

3-i-1 hernia device for the combined anterior & posterior repair of groin hernias.



VICRYL™

Completely absorbable mesh for temporary wound or organ support.



MERSILENE™

Pliable polyester mesh for the repair of abdominal wall fascial defects.

*MPPAM: Macroporos partially absorbable light weight mesh

Biosurgery

Spongostan family of products
Surgifel family of products
Surgiflo
Surgiflo with Thrombin
Evicel
Omnex



ETHICON
PART OF THE *Johnson & Johnson* FAMILY OF COMPANIES

Right Product, Right Time

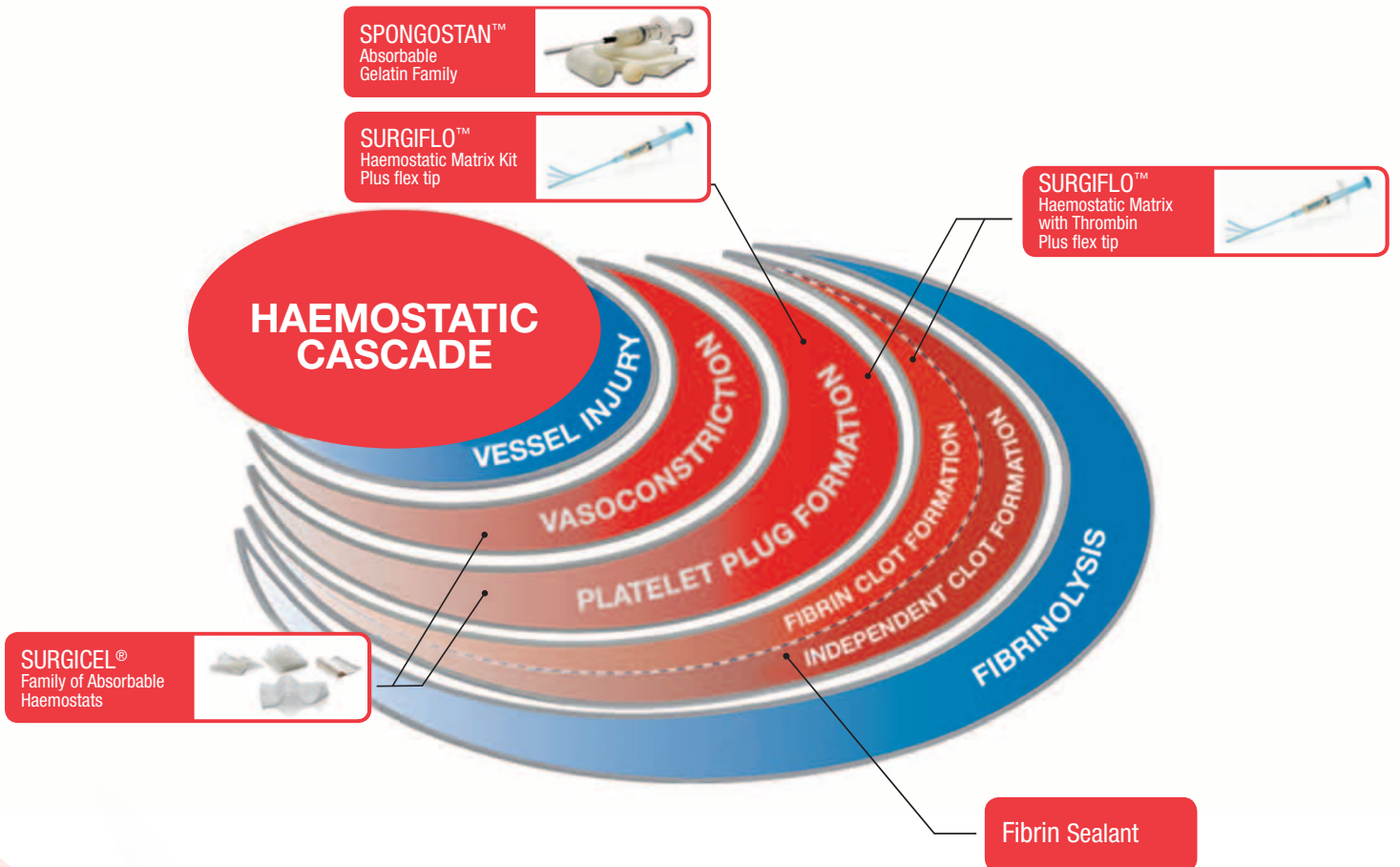

Our Commitment To You

- To provide the most comprehensive range of products to cope with the complexity of bleeding scenarios found in modern surgery
- Supporting healthcare professionals in making the right choice of product for the specific clinical situation, ensuring cost efficiency
- Constantly innovating to support healthcare professionals deliver optimal patient outcomes in the area of blood management

INTRODUCING OUR FAMILY OF EXTENSIVE HAEMOSTATIC SOLUTIONS

SURGICEL[®] SNoW[™] ABSORBABLE HAEMOSTAT

Structured Non-Woven material delivers improved speed, handling and over performance versus Surgicel[®] Original[®] due to the increased surface contact, conformability and adherence to the bleeding site. Easy to reposition without sticking to instruments. Ideal for open and minimally invasive procedures.

SURGICEL[®] FIBRILLAR[™] ABSORBABLE HAEMOSTAT

Versatility, adherence and conformability in the most demanding procedures. Unique ORC-fibril technology delivers fast haemostasis.

SURGIFLO[™] HAEMOSTATIC MATRIX KIT Plus FlexTip with Thrombin

Engineered for results. The advanced flowable haemostat achieves haemostasis in < 2 minutes when used with thrombin. Ideal for a broad range of surgical procedures and bleeding challenges.

SURGICEL[®] NU-KNIT[®] ABSORBABLE HAEMOSTAT

Dense knit material provides excellent strength in the presence of heavy bleeding. Wrap it around tissue, insert through a trocar, or suture it in place for excellent application control.

FIBRIN SEALANT

For more information on Fibrin Sealants available from Ethicon[™] Biosurgery, please contact your Product Specialist.

SURGICEL[®] ORIGINAL[®] ABSORBABLE HAEMOSTAT

For flexibility and reliability. Trusted by surgeons for half a century to stop bleeding. Proven record of safety and efficacy.

SPONGOSTAN[™]

SPONGOSTAN[™] Absorbable Gelatin Sponge is available in a variety of sizes – including a pre-shaped haemorrhoidectomy sponge, which provides ease of use during temporary packing.

For direct ordering and delivery contact you local ETHICON Biosurgery Product Specialist.

Item code	Product name	Eaches/box
SS1EU4	OMNEX Surgical Sealant	4
MS0001	SPONGOSTAN FILM	20
MS0002	SPONGOSTAN STANDARD	20
MS0003	SPONGOSTAN SPECIAL	20
MS0004	SPONGOSTAN ANAL	20
MS0005	SPONGOSTAN DENTAL	24
MS0008	SPONGOSTAN POWDER	6
MS0010	SURGIFLO hemostatic matrix	1
MS0011	SURGIFLO w Thrombin	1
MS1995	SURGIFLO endoscopic applicator	6
1901SK	SURGICEL HEMOST. 5 X 35cm	10
1902SK	SURGICEL HEMOST. 10 X 20cm	10
1903SK	SURGICEL HEMOST. 5 X 7,5cm	10
1906SK	SURGICEL HEMOST. 1,25 X 5cm	10
1940SK	SURGICEL NU-KNIT 2,5 X 2,5cm	10
1942SK	SURGICEL NU-KNIT 5 X 7,5cm	10
1943SK	SURGICEL NU-KNIT 10 X 7,5cm	10
1946M	SURGICEL NU-KNIT 15 X 22cm	10
411961	SURGICEL FIBRILLAR 2,5 X 5cm	10
411962	SURGICEL FIBRILLAR 5,1 X 10,2cm	10
411963	SURGICEL FIBRILLAR 10,2 X 10,2cm	10
2091	SURGICEL SNoW 2,5 X 5cm	10
2092	SURGICEL SNoW 5,1 X 10,2cm	10
2093	SURGICEL SNoW 10,2 X 10,2cm	10

Other Products



Other products



PRINEO*

Skin Closure System



PRINEO* Skin Closure System is intended to replace subcuticular/ intradermal suturing when there is no tension on the wound or when tension has been relieved by deep dermal or subcutaneous sutures.

PRINEO* Skin Closure System significantly reduces closure time by combining advanced mesh technology with a topical skin adhesive. The system provides microbial barrier and maintains skin approximation until removed. Enables patients to shower immediately following a procedure.

PRINEO* Skin Closure System consists of a self adhering, pressure-sensitive adhesive (PSA), polyester-based mesh for temporarily holding together the approximated skin edges of an incision and a 2-octyl cyanoacrylate liquid adhesive formulation for final skin/wound closure of incisions

Time Savings

- OR procedure time
- Anesthesia
- Post-Op Management

Suture Closure Equivalence

- Equivalent or Better Dehiscence
- Equivalent or Better Cosmesis

Ease of Use

- Wound Edge Approximation
- Minimal Learning Curve

Patient Comfort

- Ability to Shower Immediately
- No Blistering

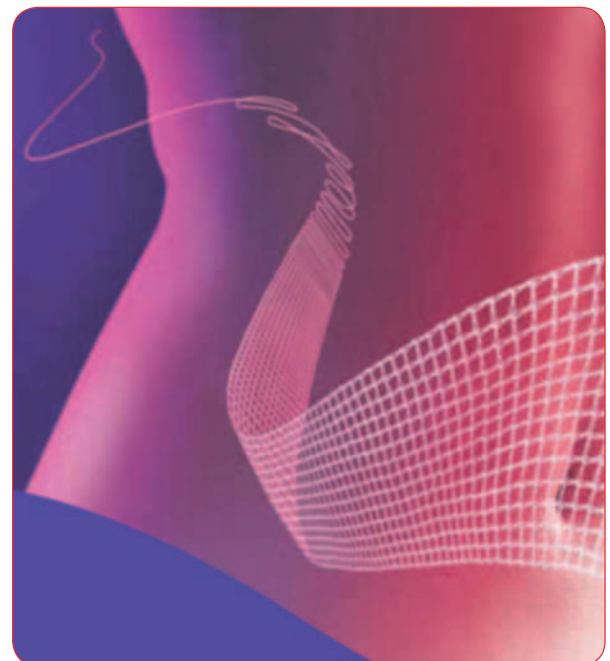

Product Name	Size	Packaging	Product Code
PRINEO* Skin Closure System	Mesh dispenser contains 60 cm of mesh Adhesive applicator contains 2-Octyl Cyanoacrylate Adhesive Formulation 3,8 ml	2 Units Per Box	CLR602

Source: Data on file. Tensile Strength: CM Rpt 07PD048 and 07PD023. Comparison of Abdominal Pressure "Are meshes with Lightweight Construction Strong Enough? Int Surg 2005; 90 S10-12

Other products



INTRODUCING DERMABOND ADVANCED

Product Overview

- Superior strength and microbial protection versus other commercially available topical skin adhesives_{2,3}
- Single-layer application and reduced drying time₂

Product Performance

- Adds 75% more strength to the wound closure than sutures alone, when used in addition to sutures₂
- In vitro inhibition of gram-positive bacteria (MRSA and MRSE) and gram-negative bacteria (E coli)*
- Provides a microbial barrier with >99% protection in vitro for at least 72 hours against organisms commonly responsible for SSIs^{4**}

Patient benefits

DERMABOND® Adhesive has benefits that enhance patient comfort and satisfaction_{5,6}, such as:

- Excellent cosmesis_{7,8}
- Ability to shower immediately after application₉
- No need to remove sutures or change dressings₇

References

2. Data of File, Ethicon, Inc.
3. Singer AJ, Perry LC, Allen RL. In vivo study of wound-bursting strength and compliance of topical skin adhesives. *Acad Emerg Med.* 2008;15(12):1290-1294.
4. Bhende S, Rothenburger S, Spangler DJ, Dito M. In vitro assessment of microbial barrier properties of Dermabond Topical Skin Adhesive. *Surg Infect (Larchmt).* 2002;3 (3):251-257.
5. Nipshagen MD, Hage JJ, Beekman W. Use of 2-octyl-cyanoacrylate skin adhesive (Dermabond) for wound closure following reduction mammoplasty: a prospective, randomized intervention study. *Plast Reconstr Surg.* 2008;122:10-18.
6. Scott GR, Carson CL, Borah G. Dermabond skin closures for bilateral reduction mammoplasties: a review of 255 consecutive cases. *Plast Reconstr Surg.* 2007;120:1460-1465.
7. Toriumi DM, O'Grady K, Desai D, Bagal A. Use of octyl-2-cyanoacrylate for skin closure in facial plastic surgery. *Plast Reconstr Surg.* 1998;102:2209-2219.
8. Quinn J, Wells G, Sutcliffe T, et al. A randomized trial comparing octylcyanoacrylate tissue adhesive and sutures in the management of lacerations. *JAMA.* 1997;277(19):1527-1530.
9. Rubio PA. Use of semioclusive, transparent film dressings for surgical wound protection: experience in 3637 cases. *Int Surg.* 1991;76:253-254.



The Range at a Glance

DERMABOND* Mini	Small vial for use in the emergency room
DERMABOND* Regular	Regular vial for use in the emergency room
DERMABOND* Propen	For use in the OR
DERMABOND* Propen XL	For use in the OR, for longer incisions
DERMABOND* ADVANCED	New improved formula, for use in the OR



Product Name	Size	Packaging	Product Code
DERMABOND* Mini	0.36 ml	12 Ampoules	AHVM12
DERMABOND* Regular	0.5 ml	6 Ampoules	AHV6
DERMABOND* Regular	0.5 ml	12 Ampoules	AHV12
DERMABOND* ProPen	0.5 ml	6 Ampoules	APP6
DERMABOND* ProPen XL	0.75 ml	6 Ampoules	APPXL6
DERMABOND* Advanced	0.7 ml	6 Ampoules	ANX6
DERMABOND* Advanced	0.7 ml	12 Ampoules	ANX12

Other products

ETHICON INTRODUCES

An exciting new option for tissue control

STRATAFIX™ Knotless Tissue Control Devices—a portfolio of products appropriate for a broad range of surgical applications

Consistency—More consistent tension control and approximation during closure*

- Unique anchor design provides multiple points of fixation along the suture line, allowing tension on the suture to be maintained during closure
- Compared to traditional sutures, enables surgeons to easily manage tension and control approximation with each pass

Security—Strength and security of interrupted suturing without knot-related complications

- Anchors running along the length of STRATAFIX™ Devices provide secure fixation, eliminating the need for knots
- In preclinical studies, multiple cuts to a STRATAFIX™ Spiral Knotless Tissue Control Device did not result in tissue separation¹⁻³

Efficiency—More efficient than continuous suturing

- No need for an assistant to follow the suture line
- With equal strength and security, STRATAFIX™ Devices can close wounds substantially faster than using an interrupted technique¹⁻⁸

STRATAFIX™ Spiral Knotless Tissue Control Devices

A broad range of bidirectional devices appropriate for several closure techniques



Stratafix™
KNOTLESS TISSUE CONTROL DEVICE
Secure every pass.

STRATAFIX™ Knotless Tissue Control Devices are available in short-term, long-term, and nonabsorbable polymers in a portfolio of sizes and lengths, with multiple needle types



Consistency

More consistent tension control and approximation during closure*

Security

Strength and security of interrupted suturing without knot-related complications

Efficiency

More efficient than continuous suturing

*Compared to traditional sutures.

Stratafix™
KNOTLESS TISSUE CONTROL DEVICE
Secure every pass.

References:

1. Data on file. Ethicon, Inc. 2. Moran ME, Marsh C, Perrotti M. Bidirectional-barbed sutured knotless running anastomosis v classic Van Velthoven suturing in a model system. *J Endourol.* 2007;21(10):1175-1178. 3. Vakil JJ, O'Reilly MP, Sutter EG, Mears SC, Belkoff SM, Khanuja HS. Knee arthroscopy repair with a continuous barbed suture: a biomechanical study. *J Arthroplasty.* 2011;26(5):710-713. 4. Eickmann T, Quane E. Total knee arthroplasty closure with barbed sutures. *J Knee Surg.* 2010;23(3):163-167. 5. Einarsson JI, Chavan NR, Suzuki Y, Jonsdottir G, Vellinga TT, Greenberg JA. Use of bidirectional barbed suture in laparoscopic myomectomy: evaluation of perioperative outcomes, safety, and efficacy. *J Minim Invasive Gynecol.* 2011;18(1):92-95. 6. Levine BR, Ting N, Della Valle CJ. Use of a barbed suture in the closure of hip and knee arthroplasty wounds. *Orthopedics.* 2011;34(9):e473-e475. 7. Rodeheaver GT, Pineros-Fernandez A, Salopek LS, et al. Barbed sutures for wound closure: in vivo wound security, tissue compatibility and cosmesis measurements. In: Transactions from the 30th Annual Meeting of the Society for Biomaterials; Mount Laurel, NJ; 2005. p. 232. 8. Warner JP, Gutowski KA. Abdominoplasty with progressive tension closure using a barbed suture technique. *Aesthet Surg J.* 2009;29(3):221-225. 9. *Wound Closure Manual.* 2007. Ethicon, Inc.

Other products

Stratafix™

Spiral PDO

KNOTLESS TISSUE CONTROL DEVICE

Needle	Length	Size	5-0	4-0	3-0	2-0	0	1
19 mm, 3/8 Circle Reverse Cutting, FS-2	7 cm x 7 cm		SXPD2B421	SXPD2B422				
	14 cm x 14 cm			SXPD2B423				
26 mm, 3/8 Circle Reverse Cutting, FS	14 cm x 14 cm				SXPD2B417	SXPD2B418		
	24 cm x 24 cm				SXPD2B419	SXPD2B420		
26 mm, 1/2 Circle Reverse Cutting, CP-2	24 cm x 24 cm						SXPD2B415	SXPD2B416
36 mm, 1/2 Circle Reverse Cutting, OS-6	24 cm x 24 cm							SXPD2B200
	30 cm x 30 cm							SXPD2B201
40 mm, 1/2 Circle Reverse Cutting, OS-8	36 cm x 36 cm							SXPD2B202
17 mm, 3/8 Circle Tapercut, V-4	24 cm x 24 cm			SXPD2B426				
26 mm, 3/8 Circle Tapercut, V-26	24 cm x 24 cm			SXPD2B424				
	14 cm x 14 cm			SXPD2B425				
22 mm, 1/2 Circle Taper Point, CT-3	14 cm x 14 cm						SXPD2B404	
26 mm, 1/2 Circle Taper Point, SH	10 cm x 10 cm					SXPD2B413		
	14 cm x 14 cm					SXPD2B414		
36 mm, 1/2 Circle Taper Point, MH	7 cm x 7 cm					SXPD2B406		
	14 cm x 14 cm					SXPD2B407	SXPD2B409	
	24 cm x 24 cm					SXPD2B408	SXPD2B410	
	30 cm x 30 cm						SXPD2B411	
	36 cm x 36 cm					SXPD2B412		
36 mm, 1/2 Circle Taper Point, CT-1	14 cm x 14 cm							SXPD2B401
	24 cm x 24 cm							SXPD2B402
	30 cm x 30 cm							SXPD2B403
36 mm, 1/2 Circle Taper Point, MO-4	36 cm x 36 cm						SXPD2B400	
48 mm, 1/2 Circle Taper Point, CTX	36 cm x 36 cm						SXPD2B405	

Stratafix™

Spiral PGA-PCL

KNOTLESS TISSUE CONTROL DEVICE

Needle	Length	Size*	5-0	4-0	3-0	2-0	0	1
19 mm, 3/8 Circle Reverse Cutting, FS-2	7 cm x 7 cm			SXMD2B405	SXMD2B404			
	14 cm x 14 cm			SXMD2B407	SXMD2B406			
	30 cm x 30 cm			SXMD2B409	SXMD2B408			
24 mm, 3/8 Circle Reverse Cutting, FS-1	30 cm x 30 cm			SXMD2B150	SXMD2B410			
26 mm, 3/8 Circle Reverse Cutting, FS	14 cm x 14 cm				SXMD2B411			
	30 cm x 30 cm			SXMD2B413	SXMD2B412			
26 mm, 1/2 Circle Reverse Cutting, CP-2	14 cm x 14 cm					SXMD2B414		
17 mm, 1/2 Circle Taper Point, RB-1	16 cm x 16 cm			SXMD2B403	SXMD2B402			
36 mm, 1/2 Circle Taper Point, MH	14 cm x 14 cm					SXMD2B400		
	36 cm x 36 cm					SXMD2B401		

Stratafix™

Spiral Polypropylene

KNOTLESS TISSUE CONTROL DEVICE

Needle	Length	Size*	5-0	4-0	3-0	2-0	0	1
22 mm, 1/2 Circle Taper Point, CT-3	14 cm x 14 cm						SXPL2B401	
36 mm, 1/2 Circle Taper Point, CT-1	24 cm x 24 cm							SXPL2B400

STRATAFIX™ Knotless Tissue Control Devices are available in short-term, long-term, and nonabsorbable polymers in a portfolio of sizes and lengths, with multiple needle types.

*Represents tensile suture size.
See IFU for additional information.

BLAKE* Silicone Drains

BLAKE Drains offer excellent drainage with four continuous channels that provide greater tissue contact area than regular perforated drains in addition to multiple drainage routes to resist clogging.¹ BLAKE Drains are constructed of silicone, with a solid-center design for strength and flexibility.





The drains are available with and without Ethicon's patented bendable TROCAR technology, which can be angled to facilitate easier placement of the drain (Round Hubless BLAKE Drains only).

The design of the drains allows greater patient comfort and enhanced ambulation. Patients experience less discomfort upon removal, greater ease of mobility postoperatively, and less discomfort during patient movement and deep breathing exercises.^{2,3,4}

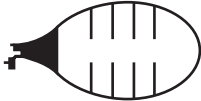

REFERENCES

- 1 Frankel TL. Silastic drains vs conventional chest tubes after coronary artery bypass. *Chest*. 2003; 124: 108-113.
- 2 Payne M. Left pleural effusion after coronary artery bypass decreases with a supplemental pleural drain. *Ann Thorac Surg*. 2002; 73:149-152.
- 3 Obney JA. A method for mediastinal drainage after cardiac procedures using small silastic drains. *Ann Thorac Surg*. 2000; 70:1109-1110.
- 4 Gundy SR. Facile minimally invasive cardiac surgery via ministernotomy. *Ann Thorac Surg*. 1998; 65:1100-1104.

Product	Material	Packaging	Code
J-VAC RESERVOIRS			
	100 cc Bulb Suction Reservoir	10 Per Box	2160
		150 ml Reservoir 450 ml Reservoir 300 ml Reservoir	10 Per Box 10 Per Box 10 Per Box
SILICONE DRAINS			
	7 mm Flat, 3/4 Fluted	10 Per Box	2210
	10 mm Flat, 3/4 Fluted		2213
	10 mm Flat, Full Fluted		2214
	10 mm Flat, Full Fluted, 3/16" Trocar		2215
	Hubless, 10 FR Round	10 Per Box	2226
	Hubless, 10 FR Round, 1/8" Trocar		2227
	Hubless, 15 FR Round		2228
	Hubless, 15 FR Round, 3/16" Trocar		2229
	Hubless, 19 FR Round		2230
	Hubless, 19 FR Round, 1/4" Trocar		2231
	Hubless, 19 FR Round, 1/4" Bendable Trocar		2232
	Hubless, 15 FR Round, 3/16" Bendable Trocar		2233
Hubless, 24 FR Round	2234		
CARDIO CONNECTORS			
	Cardio Connector 1:1	20 Per Box	BCC1
	Cardio Connector 2:1	20 Per Box	BCC2
	Cardio Connector 3:1	20 Per Box	BCC3

POWERSTAR* bipolar scissors



BIPOLAR SCISSORS FOR OPEN SURGERY

PowerStar scissors are multifunctional, for precise cutting, dissecting and achieving hemostasis with one instrument.

This leads to fewer instrument changes, thus reducing operating time and allowing an uninterrupted focus on the surgical site.

The safety of advanced bipolar technology mini-mises undesired collateral tissue damage, as the current only passes through the tissue between the blades.

Because of the short bipolar current pathway, PowerStar may be a safer alternative to monopolar surgery in patients with pacemakers or implants and may reduce ECG interferences.

The two blades of the scissors are insulated from one another to form the active electrodes of the bipolar instrument. This is achieved by applying a ceramic coat to one surface of the scissor blade and clear surface hardening to the other. An insulated screw is inserted and the handles are coated.

PowerStar scissors are available in various lengths and designs to best suit your requirements. Cables with different connectors can be obtained to ensure compatibility with most electrosurgery generators.

POWERSTAR®

POWERSTAR* bipolar scissors

	Product	Code
	PowerStar Tenotomy 115 mm (4 1/2') curved	BP 100
	PowerStar Mayo 170 mm (6 3/4') curved	BP 720
	PowerStar Metzenbaum 175 mm (7') curved	BP 520
	PowerStar Metzenbaum 230 mm (9') curved	BP 540
	PowerStar Metzenbaum 280 mm (11') curved	BP 560
	PowerStar Metzenbaum Fine 175 mm (7') curved	BP 320
	PowerStar Metzenbaum Fine 230 mm (9') curved0	BP 340
	PowerStar Metzenbaum Fine 280 mm (11') curved	BP 360

POWERSTAR* Cable

Generator	Other information	Code
Martin, Berchtold, Wolf, Aesculap	5 m	BP 910
Erbe, Storz	5 m	BP 930
Pegasys, Valleylab	5 m, fixed "banana"	BP 940

PROXIMATE PLUS MD







Stapler-grip Skin Staplers

Ease of Use

- The ergonomic design of the non-reloadable, disposable Proximate Plus handle ensures easy handling.
- The staples are applied by pressing the handle, with no further movement in any direction.

Excellent Cicatrical Results

- The large opening situated on the head of the stapler enables ideal tissue placement under the crown of the staple and perfect central positioning relative to the incision.
- Consistent staple formation ensures good cosmesis.
- Polytetrafluorethylene (PTFE) lubricant coats the staples facilitating penetration and less painful removal after wound healing.
- Two staple sizes accommodate all incision types.

		Staple size	Staple span	No. of staples	Pieces/box	Product Code
	Rotating head	Wide	6,9 mm	35	6	PRW35
	Fixed head	Regular Wide	5,7mm 6,9mm	35 35	6 6	PXR35 PXW35
	Fixed head	Regular Wide	5,7mm 6,9 mm	35 35	6 6	PMR35 PMW35
	STAPLE EXTRACTOR				12	PSX

Tapes and Cords

Needle	Material	Size	Length	Description	Color	Number per box	Code
	ETHIBOND* Cord	1 MM	150		○	24	EH381E
2 x BP-2	MERSILENE* Cord	0,9MM	40	48mm blunt point needle	○	12	RS62G
Non-needed	MERSILENE* Tape	4MM	75		●	24	EH396E
Non-needed	MERSILENE* Tape	5MM	30		○	12	RS5MG
Non-needed	MERSILENE* Tape	7MM	90		●	12	EH397G
2 x BP-1	MERSILENE* Tape	5MM	40	65mm blunt point needle	○	12	RS21G
2 x CTX	MERSILENE* Tape	5MM	40	48mm taper point needle	○	12	RS22G
2 x BP-3	MERSILENE* Tape	5MM	40	35mm blunt point needle	○	12	RS23G
CT-1	PDS* Cord	0,8MM	75	36mm taper point needle	●	12	Z809G
CCS	PDS* Cord	1MM	75	48mm cutting needle	●	12	Z812G
2 x V-68	PDS* Cord	1,3MM	75	70mm straight TAPERCUT* needle	●	3	ZK1328
V-40	PDS* Cord	1,5MM	75	48mm TAPERCUT* needle	●	12	Z838G
Non-needed	PDS* Cord	2MM	70	With transosseus wire for temporary stress protection of anterior cruciate ligament	●	3	ZK2017
Non-needed	PDS* Tape	5MM	30		●	3	ZH503
Non-needed	PDS* Tape	7,5MM	60		●	3	ZH706
Non-needed	PDS* Tape	10MM	30		●	3	ZH1003
BP-1	VICRYL* Tape	3MM	60	65mm blunt point needle	●	12	V152G
BP-2	VICRYL* Tape	3MM	60	48mm blunt point needle	●	12	V153G
PB-6W	VICRYL* Tape	3MM	60	69mm blunt ski needle	●	12	V159G
Non-needed	VICRYL* Tape	10MM	30		●	3	VH1003
Non-needed	Cotton Umbilical Tape		75		○	24	U11C
Non-needed	Nylon Tape	3MM	70		○	12	W275
		6 MM	70		○	12	W277

Other products

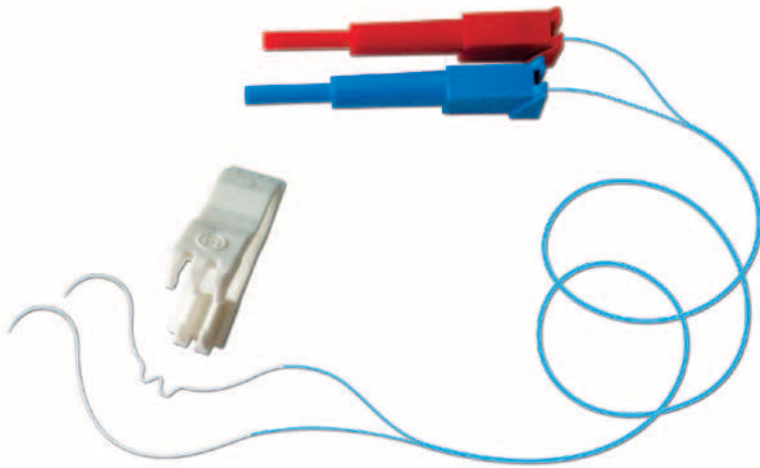

Temporary Cardiac Pacing Wires Bipolar Electrodes

Characteristics

Braided steel wire.

Each kit contains one bipolar electrode, 2 plugs (one red, one blue) and a z-clip.

Needles	Size Usp	length cm	other	no per box	code
<p>KS 60 mm</p> <p>RB-1 17 mm</p>	3-0	60		6	BPW13
<p>KS 60 mm</p> <p>SH 26 mm</p>	3-0 3-0 3-0	60 200 200		6 6 6	BPW11 BPW211 BPW251

Monopolar Electrodes

Characteristics

Braided steel wire.





Needles	Size Usp	length cm	other	no per box	code
<p>KS 60 mm</p> <p>SH 26 mm</p>	3-0	2x60	Kit with plugs	6	TSE11
<p>KS-S 60 mm</p> <p>SH 26 mm</p>	3-0	60		24	MPW10E

ENDOLOOP*

Size mm	Suture Color	Length (cm)	Other information	Number per box	Code
3-0	●		PDS* II loop ligature	12	MIC108G
2-0	●		PDS* II loop ligature	12	MIC109G
0	●		PDS* II loop ligature	12	MIC110G
0	●	50	VICRYL* loop ligature	12	EJ11
0	●	50	PDS* loop ligature	12	EZ11
0	●	90	PROLENE* loop	12	EH464G
1	●		VICRYL* loop ligature	24	VS354E
1	●		PDS* II loop ligature	12	MIC111G
1	●		PDS* II loop ligature, large	12	MIC113G

Other products

Endosutures

Needle	Size mm	Suture Color	Length (cm)	Other information	Number per box	Code
 BB	17 mm	3-0	7	PDS* II, with 2 medium-sized ABSOLOK clips	24	MIC54E
		3-0	10	PDS* II, with 2 medium-sized ABSOLOK clips	24	MIC55E
 ST-4 VISI-BLACK	19 mm	4-0	20	VICRYL*	36	MIC103H
		3-0	20	VICRYL*	36	MIC573H
		3-0	7	PDS* II, with 2 medium-sized ABSOLOK clips	24	MIC52E
		2-0	100	PDS* II ETHI-ENDO-NAHT Suture ligature	12	MIC133G
SKI-22	22 mm	2-0	20	Silk	24	E4103S
 JB	26 mm	2-0	20	PDS* II	36	MIC160H
		2-0	120	ETHIBOND* Excel	36	MIC253H
 JBT VISI-BLACK	26 mm	3-0	20	PDS* II	36	MIC182H
		2-0	120	ETHIBOND* Excel	36	MIC252H
		2-0	100	PDS* II ETHI-ENDO-NAHT Suture ligature	12	MIC131G
		3-0	40	VICRYL* Loop	36	MIC540H
		3-0	20	VICRYL*	36	MIC552H
		3-0	20	VICRYL*	36	MIC582H
		2-0	120	VICRYL*	36	MIC585H
		3-0	120	VICRYL*	36	MIC586H

ETHILOOP* Silicone Vessel Slings



Needle	Size mm	Suture Color	Length (cm)	Other information	Number per box	Code	
BPS-4 	25 mm	1,1	○	45	2 per pack, 3/8 circle blunt point needle	24	EH7700E
Non-neededled	1,3	○	45	2 per pack	24	EH382E	
	1,3	●	45	2 per pack	24	EH383E	
	1,3	●	45	2 per pack	24	EH384E	
	2	○	45	2 per pack	6	EH386	
	2	●	45	2 per pack	6	EH387	
	2	●	45	2 per pack	6	EH388	
	2	●	45	2 per pack	6	EH389	

Other products

PDS* Plates

PDS*Plates (poly-p-dioxanone) Synthetic absorbable implant for orbital floor repair

DESCRIPTION	PACKAGING	CODE
0.25mm x 30mm x 40mm	3 packs per box	ZX3
0.5mm x 30mm x 40mm	3 packs per box	ZX4
0.25mm x 40mm x 50mm	3 packs per box	ZX5
0.5mm x 40mm x 50mm	3 packs per box	ZX6
0.15mm x 30mm x 40mm	3 packs per box	ZX7
0.15mm x 40mm x 50 mm	3 packs per box	ZX8



ZX3

0.25mm x 30mm x 40mm

ZX4

0.5mm x 30mm x 40mm



ZX5

0.25mm x 40mm x 50mm

ZX6

0.5mm x 40mm x 50mm



ZX7

0.15mm x 30mm x 40mm
with perforations



ZX8

0.15mm x 40mm x 50mm
with perforations

Pledgets

Needle	Size mm	Description	Number per box	Code
ETHSORB* Pledget	15mm x 30mm x 1 mm	Absorbable pledget	12	ZV1530G
ETHSORB* Pledget	15mm x 90mm x 1 mm	Absorbable pledget	6	ZV1590
Teflon pledget	3mm x 3mm	Firm non-absorbable pledget, 5 pieces per pack	36	X948H
Teflon pledget	3mm x 6mm	Firm non-absorbable pledget, 5 pieces per pack	36	X273H
Teflon pledget	8mm x 5mm	Soft non-absorbable pledget, 2 pieces per pack	12	X619G
Teflon pledget	8mm x 5mm	Firm non-absorbable pledget, 2 pieces per pack	36	X627H
Teflon pledget	20mm x 40mm	Soft non-absorbable pledget, 1 piece per pack	12	EH370G

ETHSORB* Absorbable Femur Plugs

Needle	Size mm	Description	Number per box	Code
Femur Plug	30mm (top) * 8mm (bottom)		6	ZV3000
Applicator		Reusable, non-sterile	1	ZV2001

Other products

Product	Description	Number per box	Code
Suture cabinet, basic unit	8 lots	1	R8
Suture cabinet extension unit	8 lots	1	R9
Bone wax	2,5 g	24	W810T
Polypropylene buttons		12	520G
Cataract Procedure Kit	Silk 4-0 FS-3 30cm, ETHILON* 10-0 TG140-6 25cm	12	W7700
Retention Bridge	3 adjustable bridges per pack	6	RSB5
ETHITOUCH* 21x30cm	Polyester fleece for temporary wound covering	3	EH467



● 1/2 Circle Taper Point
▲ 1/2 Circle Cutting
▲ 3/8 Circle Cutting



















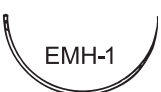

FSH-26	18 mm	FCP-20	21 mm	FFS-22	17 mm
FSH-24	21 mm	FCP-18	23 mm	FFS-18	24 mm
FSH-22	24 mm	FCP-16	29 mm	FFS-16	29 mm
FSH-20	29 mm	FCP-14	32 mm	FFS-14	32 mm
FSH-18	31 mm	FCP-12	34 mm	FFS-12	36 mm
FSH-14	40 mm	FCP-10	41 mm	FFS-10	41 mm
FSH-10	50 mm	FCP-8	46 mm	FFS-8	44 mm
FSH-8	55 mm	FCP-6	49 mm	FFS-2	67 mm
FSH-2	70 mm	FCP-4	61 mm		
		FCP-2	70 mm		

● 1/2 Circle Taper Point (Heavier Wire Diameter)
● 5/8 Circle Taper Point (Heavier Wire Diameter)
▲ 1/2 Circle Cutting (Heavier Wire Diameter)





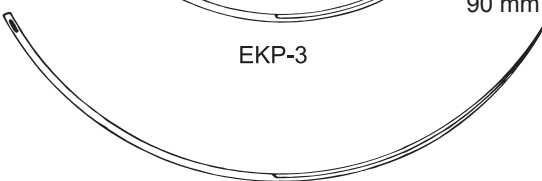

FCT-20K	28 mm	FUR-18K	32 mm	FCP-16K	28 mm
FCT-16K	37 mm	FUR-16K	36 mm	FCP-10K	40 mm
FCT-14K	40 mm	FUR-14K	40 mm	FCP-6K	50 mm
FCT-4K	65 mm	FUR-6K	60 mm		
		FUR-4K	65 mm		



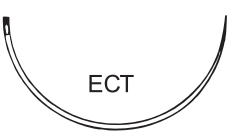



1/2 Circle Taper Point **1/2 Circle Cutting** **3/8 Circle Cutting**

 ESH-2	20 mm	 ECP-5	20 mm	 EM-2	14 mm
 ESH-1	21 mm	 EX-1	23 mm	 EFS-2	19 mm
 ESH-3	26 mm	 ECP-2	26 mm	 EFS-1	24 mm
 EMH-1	30 mm	 ECP-4	31 mm	 EFS-4	29 mm
 ESH-4	31 mm	 ECP-3	35 mm	 EFSL	30 mm
 EMH	36 mm	 ECP-1	36 mm	 EFS-5	40 mm
 ELH	40 mm	 ECP	40 mm	 EKP-2	63 mm
				 EKP-3	90 mm



1/2 Circle Taper Point Heavier Wire Diameter

 ECT-3	21 mm	 ECT	40 mm
 ECT-2	26 mm		
 ECT-4	32 mm	 ECTX	48 mm
 ECT-5	35 mm		
 ECT-1	36 mm	 ETH	68 mm

3/8 Circle Taper Point **Straight Cutting**

 ETE	32 mm	 EKS-3	89 mm
		 EKS-2	70 mm
		 EKS	64 mm
		 EKS-1	45 mm

Straight Taper Point

 EST-1	45 mm
 EST	51 mm

Index

4PK2575YE	41	1778G	121	6965H	111	8766H	81	BA2932H	68
4TB7177E	110	1780G	132	6976H	112	8776H	82	BC2573H	44
6OB2545YE	44	2160	169	6977H	112	8831H	84	BCC1	169
6OF8348G	137	2161	169	6987H	112	8832H	84	BCC2	169
8PM2544YG	42	2162	169	7060G	103	8833H	84	BCC3	169
400G	137	2163	169	7475H	86	8834H	84	BE3294	112
443H	130	2210	169	8205H	83	8841H	81	BLL6375E	111
520G	179	2213	169	8207H	81	8870H	83	BP 100	171
554G	139	2214	169	8335H	81	8871H	83	BP 320	171
603H	137	2215	169	8357H	83	8872H	83	BP 340	171
611H	100	2226	169	8411H	84	8880H	83	BP 360	171
627H	102	2227	169	8412H	84	8881H	83	BP 520	171
628H	102	2228	169	8422H	84	8889H	83	BP 540	171
629H	131	2229	169	8423H	84	8890H	83	BP 560	171
632H	130	2230	169	8424H	84	8925H	87	BP 720	171
639H	131	2231	169	8425H	84	8934H	88	BP 910	171
640H	131	2232	169	8434H	85	8935H	88	BP 930	171
644H	100	2233	169	8443H	88	8936H	88	BP 940	171
648H	102	2234	169	8444H	88	8937H	88	BPW11	174
653BG	138	2808G	103	8521H	84	8941H	87	BPW13	174
660H	100	2809G	103	8522H	84	8942H	87	BPW211	174
667H	100	2810G	103	8523H	84	8943H	87	BPW251	174
677H	131	2814G	103	8527G	85	8951H	88	BV1389	47
679H	131	3460TG	101	8556H	83	8952H	88	C267	29
680H	131	5642H	125	8557H	83	8953H	88	C427	29
681H	131	6411H	110	8558H	83	8954G	88	C459	29
682H	131	6424H	110	8580H	83	8962H	88	C1041	30
684H	131	6425H	110	8581H	83	8963H	88	CB84E	109
685H	131	6517H	113	8592H	89	8964H	88	CLR602	161
688H	130	6518H	113	8614H	90	8975H	88	D9813	111
691H	99	6521H	109	8622H	91	8976H	88	D9814	111
697H	99	6522H	109	8623H	91	8977H	88	DF2570H	44
698H	99	6523H	109	8629H	90	18501G	130	DF2573H	44
699H	99	6524H	109	8648H	89	18502G	130	E4103S	176
706H	129	6550H	109	8649H	90	18506G	119	E6551H	109
719H	131	6558H	109	8660H	90	18507G	129	E6717H	110
734H	130	6661H	114	8661H	90	18508G	131	E6762H	109
735H	131	6663H	114	8665H	90	18510G	22	E6942H	113
736H	131	6664H	114	8670H	90	18513G	119	EB2236H	113
737H	130	6681H	114	8675H	90	18514G	130	EB2316H	110
739H	131	6683H	114	8681H	89	18528G	119	EB4407H	112
746G	121	6697H	114	8682H	89	18529G	130	EH370G	179
768G	132	6698H	114	8684H	90	18531G	45	EH381E	173
769G	132	6710H	109	8685H	90	18533G	119	EH382E	177
780G	131	6832H	109	8689H	90	18534G	130	EH383E	177
783G	132	6833H	109	8695H	89	18536G	113	EH384E	177
786G	131	6834H	109	8697H	89	18537G	113	EH386	177
788G	91	6870H	109	8698H	89	18541G	88	EH387	177
869G	112	6871H	109	8699H	89	18543G	88	EH388	177
1628H	100	6872H	109	8701H	81	AA1673H	24	EH389	177
1647H	99	6873H	109	8704H	86	AB2673H	49	EH396E	173
1667H	99	6881H	110	8705H	86	AHV6	163	EH397G	173
1670H	100	6889H	110	8706H	82	AHV12	163	EH464G	175
1673H	101	6890H	110	8707H	86	AHVM12	163	EH467	179
1674H	101	6935H	111	8708H	82	ANX6	163	EH6371H	115
1696H	99	6936H	111	8710H	83	ANX12	163	EH6372H	115
1698H	99	6937H	111	8711H	83	APP6	163	EH6374H	115
1713G	92	6937LG	111	8714H	83	APPXL6	163	EH6375E	115
1716G	104	6943H	113	8717H	82	B409TG	114	EH6411H	121
1717G	104	6944H	113	8719H	86	B843H	109	EH6413H	121
1718G	104	6951H	111	8720H	82	B927H	113	EH6414H	121
1722G	121	6953H	111	8721H	86	B975H	112	EH6415H	121
1753G	92	6954H	111	8735H	81	B7714	104	EH6416H	121
1754G	91	6959G	111	8740H	81	BA1673H	21	EH6417H	121
1760G	121	6963H	111	8741H	81	BA2573H	44	EH6418H	121
1765G	120	6964H	111	8750G	90	BA2574H	44	EH6432H	115

EH6433H	115	EH7151H	90	EH7477H	82	EH7788H	87	EP7972H	86
EH6434H	115	EH7162H	99	EH7478H	82	EH7790H	100	EP8702H	82
EH6435H	115	EH7177H	100	EH7479G	111	EH7791H	100	EP8706H	82
EH6436H	115	EH7190LG	84	EH7490H	109	EH7792H	100	EP8709H	82
EH6437H	115	EH7222H	81	EH7491H	109	EH7794H	100	EP8730H	81
EH6441H	115	EH7223H	82	EH7497H	110	EH7795H	100	EP8732H	81
EH6445H	115	EH7225H	81	EH7499H	84	EH7796H	100	EP8735H	81
EH6453H	115	EH7226H	83	EH7500H	103	EH7798H	100	EP8741H	81
EH6454H	115	EH7227H	83	EH7508H	85	EH7800H	99	EP8746H	81
EH6455H	115	EH7228H	82	EH7526H	119	EH7801H	99	EP8747H	81
EH6456H	115	EH7229H	82	EH7528H	109	EH7804H	99	EP8755H	82
EH6457H	115	EH7230H	82	EH7545H	91	EH7809H	101	EP8805H	82
EH6458H	115	EH7231H	82	EH7560H	131	EH7813E	83	EP8807H	86
EH6459H	115	EH7234H	86	EH7561H	90	EH7814E	83	EP8811H	86
EH6523H	115	EH7235H	86	EH7562H	114	EH7823H	100	EP8812H	86
EH6524H	115	EH7236H	86	EH7568H	89	EH7824H	100	EP8812SLH	86
EH6525H	115	EH7237H	86	EH7573H	114	EH7825H	100	EP8889H	83
EH6562H	105	EH7238H	82	EH7579H	114	EH7826H	100	EPM8706	82
EH6584H	125	EH7240H	82	EH7581H	84	EH7828E	86	EPM8737	81
EH6604H	125	EH7241H	87	EH7582H	84	EH7835H	83	EPM8745	82
EH6605H	125	EH7242H	87	EH7584H	84	EH7845H	110	ES163H	100
EH6606H	125	EH7245H	82	EH7585H	84	EH7897G	92	ET5631SG	92
EH6621H	125	EH7251H	86	EH7586H	84	EH7900G	92	EZ11	175
EH6622H	125	EH7253H	86	EH7595G	91	EH7920H	90	F1891	91
EH6623H	125	EH7254H	83	EH7596G	91	EH7921H	85	F1894	81
EH6663H	121	EH7255H	83	EH7597G	91	EH7922G	92	F2423	102
EH6666E	121	EH7257H	83	EH7598G	91	EH7930H	99	F2707	137
EH6722E	133	EH7325H	120	EH7602H	137	EH7931H	99	F2828	87
EH6723E	133	EH7343H	129	EH7603H	137	EH7936H	100	F2829	87
EH6724H	133	EH7344H	129	EH7611	137	EH7939H	100	F2840	88
EH6736H	121	EH7345H	131	EH7623G	139	EH7943H	102	F3217	100
EH6751H	105	EH7346H	114	EH7625E	102	EH7945H	100	F4202	133
EH6762H	133	EH7350H	120	EH7627G	139	EH7954H	99	F4354	105
EH6763H	133	EH7384H	111	EH7637H	120	EH7956H	99	F6714	139
EH6764H	133	EH7397H	109	EH7638H	120	EH7957H	99	FG2819	103
EH6765H	133	EH7398H	109	EH7640H	100	EH7963G	90	FH1642H	23
EH6767H	133	EH7399H	109	EH7666G	89	EH7970H	86	FJ5272H	100
EH6768H	133	EH7400H	83	EH7668G	92	EH7972E	86	FK5242H	100
EH6804H	133	EH7401H	83	EH7673H	113	EH7975H	86	FO8444H	137
EH6806H	133	EH7402H	82	EH7674H	113	EH7976H	86	HAA6395H	113
EH6807H	133	EH7403H	82	EH7677G	137	EH7977H	86	J649	42
EH6823H	133	EH7405H	82	EH7678H	113	EH7980G	104	J694H	46
EH6824H	133	EH7406H	82	EH7679H	113	EH7984G	91	J713D	39
EH6825H	133	EH7411H	83	EH7683H	120	EH7997G	92	J740D	41
EH6833H	133	EH7412H	83	EH7684H	120	EH8000H	85	J753D	42
EH6835E	133	EH7413G	119	EH7688H	114	EH8010H	85	J764D	42
EH6836E	133	EH7417H	109	EH7691H	89	EH8014H	85	J765D	42
EH6837E	133	EH7418H	111	EH7693H	90	EH8020H	87	J774D	40
EH6853H	121	EH7420H	109	EH7694H	90	EH8021E	87	J775D	40
EH6855H	121	EH7427H	110	EH7697H	90	EH8025H	87	JA1642H	22
EH6856H	121	EH7435G	132	EH7700E	177	EH8030H	87	JA5742H	89
EH6857H	121	EH7438G	103	EH7711LG	112	EH8031H	87	JA6442H	114
EH6858H	121	EH7440G	132	EH7712LG	111	EH8032H	88	JE2672H	47
EH6884H	121	EH7446H	103	EH7715LG	111	EH8035H	87	JG2942H	71
EH6885H	121	EH7448G	103	EH7716LG	112	EH8036H	87	JJ42D	41
EH6886H	121	EH7459E	81	EH7722H	114	EH8037H	87	JM5140H	101
EH6887H	121	EH7464G	132	EH7730H	91	EH8061H	84	JV459	46
EH7113H	100	EH7469E	81	EH7758H	89	EH8062H	84	JV589	48
EH7121H	89	EH7469LG	81	EH7759H	91	EH8065H	84	JV969	46
EH7143H	100	EH7470E	81	EH7760H	114	EH8066H	84	JV1472	46
EH7144H	100	EH7471H	86	EH7764H	89	EH8086H	84	JV2024	51
EH7145H	100	EH7472H	86	EH7772H	88	EH8087H	84	JV2025	51
EH7147H	120	EH7473G	91	EH7774H	88	EH8091H	84	K803H	129
EH7148H	120	EH7474H	86	EH7775H	88	EJ11	175	K831H	129
EH7149G	131	EH7475H	86	EH7778H	88	EMM2830G	49	K832H	129
EH7150H	90	EH7476H	83	EH7779H	88	EP2775G	81	K833H	129

Index

K834H	129	MCP684H	34	MIC108G	175	MPV495H	47	OA1674G	22
K835H	129	MCP925H	33	MIC109G	175	MPV496H	47	OAL5693JG	88
K843H	129	MCP2131H	33	MIC110G	175	MPV497H	47	OB1674G	22
K844H	129	MCP3070H	33	MIC111G	175	MPV500H	47	OB1674H	22
K845H	129	MCP3100H	33	MIC113G	175	MPV683H	47	OBB5616H	88
K846H	129	MCP3110H	33	MIC131G	176	MPV684H	47	OBB5694SH	88
K861H	129	MCP3120H	33	MIC133G	176	MPV9506H	48	OBL5595LG	88
K870H	129	MCP3150H	33	MIC160H	176	MPV9526H	47	OBL5694JG	88
K871H	129	MCP3160H	33	MIC182H	176	MPV9571H	48	OBL5695LG	88
K872H	129	MCP3170H	33	MIC252H	176	MPV9580H	48	OF2923SG	68
K873H	129	MCP3200H	33	MIC253H	176	MPVCP493H	60	OH2528G	45
K881H	129	MCP3205G	34	MIC540H	176	MPVCP494H	60	OMM8378G	138
K889H	129	MCP3209G	35	MIC552H	176	MPVCP496H	60	OT2924SG	69
K890H	129	MCP3213H	34	MIC573H	176	MPVCP497H	60	P6523H	109
K891H	129	MCP3218H	33	MIC582H	176	MPVCP500H	60	P6937H	111
K942H	130	MCP3219H	33	MIC585H	176	MPVCP683H	61	P6977H	112
K943H	130	MCP3326G	35	MIC586H	176	MPVR4260H	23	PCDB1	144
K952H	130	MCP3416H	33	MN5132H	104	MPVR4270H	23	PCDD1	144
K953H	130	MCP3435G	33	MPE697H	99	MPVR4930H	23	PCDG1	144
K963G	130	MCP3625H	34	MPE698H	99	MPVR4940H	23	PCDH1	144
K964H	130	MCP3649G	35	MPE1616H	101	MPVR4960H	23	PCDJ1	144
KAA5663LG	82	MCP3650G	35	MPE1621H	99	MPVR4970H	23	PCDL1	144
KBB5661H	82	MCP4150H	33	MPE1625H	100	MPVR9360H	23	PCDM1	144
KBB5671VG	82	MCP4160H	33	MPE1667H	99	MPVR9380H	23	PCDN1	144
KBL5690JG	82	MCP4170H	33	MPE1696H	99	MPVR9913H	23	PCDR1	144
KBL5691JG	82	MCP4259H	34	MPE1698H	99	MPVR9915H	23	PCDT1	144
KCC2992E	67	MCP4260H	34	MPE1853H	101	MPVR9918H	24	PCDW1	144
KHH5662H	81	MCP4269H	34	MPE1855H	99	MPW10E	174	PDP15H	75
KHL5673JG	81	MCP4270H	34	MPE1856H	101	MPY426H	29	PDP277H	77
KV31	112	MCP4271H	34	MPE7662H	99	MPY427H	29	PDP303H	75
KV33	111	MCP4422H	35	MPE7800H	99	MPY489H	29	PDP304H	75
KV91	112	MCP4423H	35	MPE7801H	99	MPY490H	29	PDP305H	75
M436C	138	MCP4443H	35	MPE7804H	99	MPY492H	29	PDP310H	75
M624G	137	MCP4946H	34	MPE7930H	99	MPY493H	29	PDP311H	75
M649G	137	MCP4950G	34	MPE7931H	99	MPY494H	29	PDP315H	75
M651G	137	MCP5218H	33	MPE7954H	99	MPY495H	29	PDP316H	75
M660G	137	MCP5270H	33	MPE7956H	99	MPY496H	29	PDP317H	75
M8702G	82	MCP6050H	34	MPP2832H	89	MPY497H	29	PDP328H	75
M8710G	83	MCP9350H	34	MPP2834H	89	MPY500H	29	PDP329H	75
M8737G	81	ME2673H	46	MPP2835H	89	MPY501H	29	PDP333H	75
M8766	81	MEH6937N	111	MPP2854H	89	MPY683H	29	PDP334H	75
M8935	81	MEH7210G	138	MPP2858H	89	MPY684H	29	PDP335H	75
M8967	81	MEH7211G	138	MPP2861H	89	MPY935H	29	PDP338H	75
MCP212H	33	MEH7212G	138	MPP2862H	89	MPY3212H	30	PDP339H	75
MCP215H	33	MEH7213G	138	MPP7695H	89	MPY3213H	30	PDP340H	75
MCP218H	33	MEH7216G	137	MPP7757H	89	MPZ489H	70	PDP341H	75
MCP219G	33	MEH7224JG	81	MPP7764H	89	MPZ493H	70	PDP357H	76
MCP227H	33	MEH7232JG	82	MPP8026H	89	MPZ494H	70	PDP358H	76
MCP260H	34	MEH7233JG	82	MPP8604H	89	MPZ496H	70	PDP370H	76
MCP291H	35	MEH7241JG	87	MPP8681H	89	MPZ497H	70	PDP371H	76
MCP292H	35	MEH7710LG	112	MPP8682H	89	MPZ500H	70	PDP421H	78
MCP293H	35	MEH7712N	111	MPP8686H	89	MPZ501H	70	PDP422H	78
MCP428H	34	MEH7715N	111	MPP8695H	89	MPZ682H	71	PDP423H	78
MCP432H	33	MEH7716N	112	MPP8697H	89	MPZ683H	71	PDP441H	78
MCP442H	35	MEH7717N	112	MPP8698H	89	MPZ9626H	71	PDP442H	78
MCP489H	34	MEH7718LG	111	MPP8699H	89	N266H	129	PDP443H	78
MCP490H	34	MEH7719LG	111	MPP8873H	90	N267H	129	PDP458H	77
MCP492H	34	MEH8034JG	87	MPP8874H	90	NL832H	125	PDP463H	78
MCP493H	34	MF2572H	46	MPP8875H	90	NL833H	125	PDP466H	77
MCP494H	34	MF2574H	46	MPP8876H	90	NL7614H	125	PDP467H	77
MCP495H	34	MF2675H	46	MPP8877H	90	NL7615H	125	PDP468H	77
MCP496H	34	MH2976E	70	MPV489H	47	NL7616H	125	PDP485H	77
MCP497H	34	MIC52E	176	MPV490H	47	NP0001	27	PDP490H	78
MCP498H	34	MIC54E	176	MPV492H	47	NP0127	30	PDP493H	78
MCP500H	34	MIC55E	176	MPV493H	47	NP0128	28	PDP494H	78
MCP683H	34	MIC103H	176	MPV494H	47	NS2820	103	PDP496H	78

PDP497H	78	PLL6375H	110	PVM2M3	150	UMN3	147	V303H	39
PDP683H	78	PML1	152	PVM2N3	150	UMP3	147	V304H	39
PDP684H	78	PMM3	152	PVM2P3	150	UMR3	147	V305H	39
PDP864H	75	PMN3	152	PVML1	151	UMT1	147	V306H	39
PDP924H	75	PM3	152	PVMM1	151	UPPL2 Large	149	V310H	39
PDP925H	75	PMR3	152	PVMN1	151	UPPM2 Medium	149	V311H	39
PDP925ST	76	PMR35	172	PVPM	145	UPPS2 Small	149	V312H	39
PDP926H	75	PMW35	172	PVPS	145	V13H	41	V315H	40
PDP969H	77	PN1695H	21	PX1010	112	V14H	41	V316H	40
PDP976H	75	PN1800H	95	PX1011	111	V15H	41	V317H	40
PDP983H	77	PN1809H	96	PXR35	172	V16H	41	V318H	40
PDP984H	77	PN1811H	96	PXW35	172	V32H	23	V322H	40
PDP1057H	77	PN1812H	96	PZ2571H	39	V38G	24	V323H	40
PDP1310H	75	PN1821H	95	R8	179	V39G	24	V324H	40
PDP1311H	75	PN1830H	95	R9	179	V55H	21	V325H	40
PDP1312H	75	PN1831H	96	R424H	119	V62H	21	V327H	41
PDP1702H	76	PN1836G	95	R633H	120	V70H	21	V328H	41
PDP1722H	76	PN1837H	95	R647H	120	V76H	22	V329H	41
PDP1926T	76	PN1839H	96	R665H	120	V81H	22	V332H	41
PDP1932T	77	PN1852H	95	R670H	120	V100H	40	V333H	41
PDP1933T	77	PN1855H	95	R677H	120	V101H	40	V334H	41
PDP2971H	75	PN1856H	95	R691H	120	V102H	40	V335H	41
PDP3060H	75	PN1859H	95	R832H	119	V113H	41	V336H	41
PDP3100H	75	PN1860H	95	R833H	119	V115H	41	V338H	41
PDP3160H	75	PN1863H	95	R834H	119	V119G	49	V339H	41
PDP3170H	75	PN1889H	95	R843H	119	V120G	49	V340H	41
PDP5270H	75	PN1890G	95	R844H	119	V133H	39	V341H	41
PDP9179H	77	PN2872H	96	R845H	119	V140G	45	V345H	41
PDP9184H	77	PN2925SG	66	R871H	119	V152G	173	V346H	41
PDP9201H	75	PN5695H	85	R872H	119	V153G	173	V347H	41
PDP9234H	76	PN6376H	110	R943H	119	V159G	173	V348H	41
PDP9236T	76	PN8500H	95	R964H	119	V170H	42	V350H	42
PDP9237T	76	PN8502H	95	RM3015	152	V204G	51	V351H	42
PDP9261T	76	PN8506H	95	RM3030	152	V205G	51	V352H	42
PDP9262T	76	PN8510H	95	RS5MG	173	V206G	51	V353H	42
PDP9299H	77	PN8516H	96	RS21G	173	V207G	51	V358H	42
PDP9333H	77	PN8520H	96	RS22G	173	V213H	39	V359H	42
PDP9334H	77	PN8522H	95	RS23G	173	V214H	39	V360H	42
PDP9950H	78	PN8529H	96	RS62G	173	V215H	39	V362H	42
PDP9965H	76	PN8602H	95	RS71G	112	V219H	39	V363H	42
PDP9966T	76	PN8605H	96	RS72G	112	V220H	39	V364H	42
PDP9967T	76	PN8606H	95	RSB5	179	V224H	40	V365H	42
PDPL955H	75	PN8607H	95	S2450	100	V225H	40	V366H	42
PDPS925ST	76	PN8612H	95	S2455	100	V226H	40	V367H	42
PDPS926T	76	PN8613H	95	SN1G	139	V228H	40	V370H	42
PF6315H	109	PN8619H	95	SN13G	139	V230H	44	V371H	42
PG2592H	40	PN8622H	96	SN17G	139	V231H	44	V372H	42
PGG5613H	84	PN8623H	96	SP4491	115	V237H	41	V375H	43
PGG5614H	84	PN8700H	95	STRAP12	146	V239G	51	V376H	43
PGG5694H	84	PN8704H	95	STRAP25	146	V240G	45	V377H	43
PGG5695H	84	PN8706H	95	STRAP25R	146	V242H	40	V380H	43
PH2574H	40	PN8709H	95	T4215AH	27	V243H	40	V381H	43
PHSE1	153	PN8714H	95	T4682H	29	V245H	40	V383H	49
PHSL1	153	PN8715H	96	TB6377H	110	V246H	40	V384H	47
PHSM1	153	PN8803G	96	TC6377H	110	V247H	40	V385H	47
PHY715R	143	PN8809E	95	TS55	152	V255H	41	V386H	47
PHY1015V	143	PNN5695E	85	TSE11	174	V269H	41	V387H	47
PHY1515Q	143	PQQ5660E	83	U11C	173	V270H	41	V388H	47
PHY1520R	143	PQQ5671H	83	U7000	104	V276H	44	V391H	48
PHY1520V	143	PRW35	172	U7003	103	V279H	44	V392H	48
PHY2025V	143	PS2925SG	66	U7061	103	V291H	48	V392ZG	48
PHY2030R	143	PS2926G	66	UHSL	148	V292H	48	V393G	48
PHY2535V	143	PSX	172	UHSM	148	V292ZH	48	V393H	48
PHY3035R	143	PUU2971E	65	UHSOV	148	V293H	48	V397H	48
PHY3050R	143	PUU5662SH	83	UML1	147	V301G	51	V398H	48
PK5696H	84	PV2924SH	65	UMM3	147	V302H	39	V400G	51

Index

V416H	40	V586H	48	V946H	41	V4421H	23	VCP322H	55
V421H	48	V587H	48	V948H	41	V4431H	23	VCP323H	55
V422H	48	V588H	48	V960H	42	V4550H	22	VCP324H	55
V423H	48	V601H	43	V965	50	V4721H	22	VCP326H	56
V426H	39	V602H	43	V965E	52	V4851H	22	VCP329H	56
V429G	50	V603H	43	V970G	51	V4861H	22	VCP330H	56
V436H	41	V614H	51	V971G	51	V4930H	23	VCP333H	56
V439G	49	V615H	51	V978H	52	V4940H	23	VCP334H	56
V440G	49	V616H	51	V990H	45	V4960H	23	VCP335H	56
V441H	48	V617H	51	V991H	45	V4970H	23	VCP336H	56
V442H	48	V618H	51	V994G	44	V5170H	22	VCP338H	56
V443H	48	V620H	44	V994H	44	V5180H	22	VCP339H	56
V449G	49	V623E	51	V998G	44	V6830H	23	VCP340H	56
V450G	49	V624E	51	V998H	44	V7642E	41	VCP341H	56
V451H	48	V625E	51	V999H	44	V7740E	40	VCP345H	56
V452H	48	V626E	51	V1027G	39	V7840E	40	VCP346H	56
V453H	48	V627H	51	V1028H	39	V7902H	22	VCP347H	56
V460H	46	V628H	51	V1057H	46	V8645E	24	VCP348H	56
V461H	46	V632H	52	V1058H	46	V8646E	24	VCP351H	57
V465H	46	V633H	52	V1059H	46	V8980E	24	VCP352H	57
V466H	46	V634H	52	V1204G	51	V9360H	23	VCP353H	57
V467H	46	V635H	52	V1205G	51	V9380H	23	VCP358H	57
V468H	46	V636E	52	V1206G	51	V9450H	21	VCP359H	57
V472H	46	V637E	52	V1207G	51	V9460H	21	VCP360H	57
V473H	46	V638H	52	V1208G	51	V9580H	21	VCP363H	57
V474H	46	V642H	52	V1210G	24	VB50H	83	VCP365H	57
V475G	46	V643H	52	V1211G	24	VC2575H	43	VCP366H	57
V478H	46	V644H	52	V1214E	52	VC2973H	67	VCP367H	57
V479H	46	V645H	52	V1215E	52	VC5673H	85	VCP370H	57
V480H	46	V647E	52	V1216E	52	VCC2573H	43	VCP371H	57
V482H	46	V652E	51	V1217E	52	VCP14H	56	VCP372H	57
V485H	46	V653E	51	V1218H	52	VCP15H	56	VCP375H	58
V486H	46	V654E	51	V1219H	52	VCP100H	55	VCP376H	58
V489H	47	V662H	49	V1220G	24	VCP102H	55	VCP391H	61
V490H	47	V663H	49	V1223H	52	VCP214H	55	VCP392H	61
V492H	47	V664H	49	V1224H	52	VCP215H	55	VCP392ZG	61
V493H	47	V667H	39	V1225H	52	VCP219H	55	VCP392ZH	61
V494H	47	V670G	50	V1226H	52	VCP220H	55	VCP393H	61
V496H	47	V671G	50	V1227E	52	VCP224H	55	VCP397H	61
V497H	47	V683H	47	V1228E	52	VCP240H	59	VCP398H	61
V507G	46	V684H	47	V1229H	52	VCP242H	55	VCP416H	55
V516H	44	V686H	47	V2130H	21	VCP243H	55	VCP422H	61
V517H	44	V734E	39	V2140H	21	VCP245H	55	VCP423H	61
V518H	44	V735G	39	V2150H	21	VCP246H	55	VCP434H	55
V519H	44	V736G	41	V2180H	21	VCP247H	55	VCP437H	56
V520H	48	V744E	41	V2190H	21	VCP250H	56	VCP438H	56
V523H	49	V782H	39	V2530G	49	VCP251H	56	VCP441H	61
V524H	49	V783G	40	V2910H	23	VCP253H	56	VCP442H	61
V546G	49	V792E	39	V2912G	22	VCP270H	56	VCP443H	61
V547G	49	V799E	39	V2920H	23	VCP276H	59	VCP451H	61
V548G	49	V829E	45	V2930G	23	VCP278H	59	VCP452H	61
V549G	49	V869H	46	V2930H	23	VCP279H	59	VCP453H	61
V554G	49	V870E	46	V3030H	39	VCP291H	61	VCP458H	60
V555G	50	V903H	52	V3040H	39	VCP292H	61	VCP459H	60
V557G	49	V904H	52	V3100H	39	VCP292ZH	61	VCP460H	60
V570G	50	V905E	52	V3110H	39	VCP293H	61	VCP466H	60
V571G	50	V906E	52	V3120H	39	VCP303H	55	VCP467H	60
V572G	50	V907E	52	V3150H	40	VCP304H	55	VCP468H	60
V574G	49	V910H	52	V3160H	40	VCP305H	55	VCP473H	60
V575G	50	V911E	52	V3170H	40	VCP310H	55	VCP474H	60
V577G	50	V912E	52	V4150H	21	VCP311H	55	VCP479H	60
V581G	42	V924H	39	V4160H	21	VCP312H	55	VCP480H	60
V582G	42	V925H	39	V4170H	21	VCP315H	55	VCP482H	60
V583G	42	V926H	39	V4260H	23	VCP316H	55	VCP485H	60
V585G	42	V944H	41	V4416H	40	VCP317H	55	VCP486H	60
V585H	48	V945H	41	V4420H	23	VCP318H	55	VCP493H	60

VCP494H	60	VCP1226H	62	W10B82	109	W2810	103	W8702S	82
VCP496H	60	VCP1227E	62	W211	133	W2812	103	W8703	86
VCP496ZH	60	VCP1228E	62	W223	133	W2813	103	W8718	82
VCP497H	60	VCP1229H	62	W225	133	W2829	103	W8725	82
VCP500H	60	VCP1472H	60	W275	173	W2830	103	W8802	86
VCP516H	59	VCP3100H	55	W277	173	W2850	103	W8807	86
VCP517H	59	VCP3110H	55	W525	90	W2860	103	W8815	87
VCP518H	59	VCP3160H	55	W527	90	W2870	103	W8816	87
VCP519H	59	VCP3170H	55	W528H	131	W2871	103	W8845	87
VCP520H	59	VCP5020H	59	W529H	131	W2881	103	W8849	87
VCP581G	57	VCP5891G	57	W538	90	W2898	105	W8873T	90
VCP585H	61	VCP7740E	55	W558	101	W2899	105	W8874T	90
VCP586H	61	VCP7750E	55	W604	131	W3020	30	W8877T	90
VCP587H	61	VCP7840E	55	W630	91	W3113	30	W8879T	90
VCP589H	61	VCP9215H	56	W689	101	W3114	30	W9095T	67
VCP602H	58	VCP9221H	58	W738	102	W3115	30	W9108H	65
VCP603H	58	VCP9245H	57	W739	102	W3200	27	W9109H	65
VCP624E	62	VCP9246H	57	W742	85	W3204	29	W9132H	65
VCP625E	62	VCP9287H	60	W748	102	W3205	29	W9168	67
VCP626E	62	VCP9295H	60	W760	102	W3206	29	W9172	45
VCP627H	62	VCP9335H	58	W795	101	W3207	29	W9215	41
VCP628H	62	VCP9360H	59	W797	101	W3208	29	W9216	41
VCP633H	62	VCP9361H	59	W810T	179	W3212	30	W9236T	66
VCP634H	62	VCP9377H	59	W811	131	W3213	30	W9237T	66
VCP635H	62	VCP9505H	61	W816	131	W3230	29	W9245	42
VCP636E	62	VCP9506H	61	W818	132	W3326	30	W9261T	66
VCP637E	62	VCP9901H	59	W870	132	W3441	27	W9262T	66
VCP638H	62	VCP9991H	58	W902	137	W3488	28	W9286T	70
VCP649	57	VCP9995H	58	W969	111	W3489	28	W9287	46
VCP663H	61	VCP9996H	58	W975	109	W3552	30	W9324T	70
VCP683H	61	VCP9997H	58	W993	114	W3625	28	W9333T	69
VCP684H	61	VCP9999H	58	W1614T	99	W3649	30	W9334T	69
VCP694H	60	VCPJV457H	60	W1615T	101	W3650	30	W9335	44
VCP695H	60	VCPJV484H	60	W1616T	101	W3709	28	W9352T	68
VCP736G	56	VCPV13H	56	W1620T	99	W4843	112	W9360	44
VCP737G	56	VCPV269H	56	W1621T	99	W4846	112	W9361	44
VCP740G	56	VCPV327H	56	W1625T	100	W5204	125	W9362	44
VCP741G	56	VCPV332H	56	W1626T	100	W5223	125	W9377	45
VCP742G	56	VCPV350H	57	W1627T	100	W5225	125	W9380H	68
VCP744E	56	VCPV426H	55	W1685T	100	W5415	125	W9381H	68
VCP753G	57	VCPV623T	62	W1701	105	W5723	125	W9391	43
VCP754G	57	VCPV643H	62	W1756	104	W6584	113	W9436	46
VCP765G	57	VCPV944H	56	W1765	104	W6748	113	W9437	46
VCP784E	55	VCPV948H	56	W1769	104	W6760	109	W9443	47
VCP794E	55	VCPV1057H	60	W1770	104	W6831	109	W9466	45
VCP829E	59	VCPV4416H	55	W1775	120	W6917	111	W9505T	48
VCP924H	55	VCPW9467H	59	W1780	104	W6977	112	W9506T	47
VCP925H	55	VH1003	173	W1782	132	W6978	112	W9515T	47
VCP945H	56	VM101	152	W1819	132	W7700	179	W9531T	48
VCP946H	56	VM102	152	W1852T	99	W8000T	89	W9537	49
VCP969H	60	VM106	152	W1854T	101	W8007T	90	W9562	50
VCP974H	60	VM605	152	W1856T	101	W8014T	89	W9565	49
VCP988H	59	VM802	152	W1857T	99	W8015T	89	W9566	50
VCP994H	59	VM1208	152	W1858T	101	W8101	86	W9567	50
VCP998H	59	VM2515	152	W1859T	101	W8170	103	W9570T	48
VCP999H	59	VM3020	152	W1861T	99	W8304	82	W9577	51
VCP1058H	60	VR2239	24	W2775	81	W8305	82	W9580T	48
VCP1059H	60	VR2240	24	W2777	81	W8307	82	W9581T	48
VCP1214E	62	VR2286	23	W2779	91	W8400	85	W9626T	71
VCP1215E	62	VR2289	23	W2780	91	W8626	90	W9631T	71
VCP1216E	62	VS354E	175	W2783	91	W8630	91	W9756	50
VCP1217E	62	VS4000H	45	W2790	91	W8662	86	W9761	50
VCP1218H	62	VS5000H	45	W2794	91	W8664	87	W9820	45
VCP1219H	62	VS5020H	45	W2797	101	W8665	87	W9824	45
VCP1224H	62	W10B54	111	W2801	103	W8667	87	W9826	45
VCP1225H	62	W10B77	112	W2808	103	W8702	81	W9861T	71

Index

W9872T	70	X32049	113	Y3160H	27	Z421E	71	Z991H	69
W9873T	70	X32200	113	Y3170H	27	Z422E	71	Z994H	68
W9874T	70	XN9263G	66	Y3213H	27	Z423E	71	Z995H	68
W9900	45	Y212H	27	Y3214H	27	Z425E	69	Z997H	68
W9904	45	Y213H	27	Y3218H	27	Z441E	71	Z998H	68
W9911	22	Y214H	27	Y3219H	27	Z442E	71	Z999H	68
W9913	23	Y215H	27	Y3416H	27	Z443E	71	Z1002H	67
W9914	24	Y218H	27	Y3417H	27	Z452H	71	Z1012H	67
W9915	23	Y219H	27	Y3864G	27	Z458E	70	Z1013H	67
W9916	24	Y227H	27	Y4950G	29	Z463H	70	Z1032H	69
W9919	24	Y259H	28	Y5218H	27	Z464H	70	Z1033E	69
W9922	23	Y260H	28	Y5270H	27	Z466H	70	Z1057E	70
W9923	23	Y261H	28	Y7840G	27	Z467H	70	Z1058E	70
W9930	23	Y270H	28	Z13H	66	Z468H	70	Z1310H	65
W9940	23	Y291H	30	Z14H	66	Z485E	70	Z1311H	65
W9941	23	Y292H	30	Z15H	66	Z487H	70	Z1312H	65
W9945	22	Y293H	30	Z113H	66	Z489E	70	Z1316H	65
W9952H	21	Y326H	28	Z114H	66	Z490E	70	Z1370E	65
W9965T	67	Y375H	28	Z161E	67	Z493E	70	Z1701E	67
W9966T	67	Y415H	27	Z274H	68	Z494E	70	Z1702H	67
W9967T	67	Y416H	27	Z275H	68	Z496E	71	Z1711E	69
W9968	68	Y417H	27	Z276H	68	Z497E	70	Z1712H	69
W9981	39	Y418H	27	Z277H	68	Z513H	71	Z1721H	67
W9983	43	Y422H	30	Z282H	71	Z528H	65	Z1722H	67
W9984	43	Y423H	30	Z292E	71	Z582G	66	Z1751E	69
W9985	43	Y432H	27	Z293E	71	Z605E	67	Z1926G	66
W9986	43	Y442H	30	Z303H	65	Z620E	68	Z1927G	66
W9988	43	Y443H	30	Z304H	65	Z625H	72	Z1932E	68
W9990	43	Y489H	29	Z305H	65	Z626E	72	Z3100H	65
W9991	43	Y491H	29	Z310H	65	Z627E	72	Z3110H	65
W9993	43	Y492H	29	Z311H	65	Z630E	68	Z3160H	65
W9994	43	Y493H	29	Z315H	65	Z662H	72	Z3170H	65
W9995	43	Y494H	29	Z316H	65	Z663H	72	Z5270H	65
W9996	43	Y495H	29	Z317H	65	Z664H	72	ZH503	173
W9997	43	Y602H	28	Z322H	65	Z683E	71	ZH706	173
X190G	110	Y605H	28	Z323H	65	Z684E	71	ZH1003	173
X273H	179	Y625H	30	Z328H	66	Z809G	173	ZK1328	173
X535G	86	Y634H	30	Z329H	66	Z812G	173	ZK2017	173
X577H	82	Y684H	29	Z333H	66	Z838G	173	ZV1530G	179
X619G	179	Y919H	28	Z334H	66	Z864H	65	ZV1590	179
X627H	179	Y925H	27	Z335H	66	Z866H	65	ZV2001	179
X916G	81	Y946H	28	Z338H	66	Z867H	65	ZV3000	179
X948H	179	Y977G	28	Z339H	66	Z924H	65	ZX3	178
X967G	81	Y979G	28	Z340H	66	Z925H	65	ZX4	178
X976E	65	Y999H	28	Z341H	66	Z926H	65	ZX5	178
X1004G	87	Y3040H	27	Z357E	66	Z935H	65	ZX6	178
X1154G	65	Y3100H	27	Z358E	66	Z969H	70	ZX7	178
X1166H	84	Y3110H	27	Z359E	66	Z983H	70	ZX8	178
X1295H	84	Y3120H	27	Z370E	66	Z984H	70		
X32030	114	Y3150H	27	Z371E	66	Z990H	69		

ETHICON

PART OF THE *Johnson & Johnson* FAMILY OF COMPANIES

SWEDEN

JOHNSON & JOHNSON AB
Staffans väg 2
191 84 Sollentuna
Phone +46 (0)8 626 2203
Fax +46 (0)8 626 2230
E-mail cservse@its.jnj.com

DENMARK

JOHNSON & JOHNSON
Bregnerødvej 133
DK 3460 Birkerød
Phone +45 94 8204
Fax +45 94 8212
E-mail cservdk@its.jnj.com

NORWAY

JOHNSON & JOHNSON
PB 144, 1325 Lysaker
Drammensveien 288
0283 Oslo
Phone +66 77 4704
Fax +66 98 1777
E-mail cservno@its.jnj.com

FINLAND

JOHNSON & JOHNSON Finland
Vaisalantie 2
FIN-02130 ESPOO
Phone +358 (0)207 531 502
Fax +358 (0)207 531 509
E-mail cservfi@its.jnj.com

ESTONIA

JOHNSON & JOHNSON AB
Eesti filiaal
Lõõtsa 2
11415 Tallinn
Phone +372 61 77 400
Fax +372 61 77 401
E-mail cservee@its.jnj.com

LATVIA

JOHNSON & JOHNSON AB
Latvijas filiāle
Mūkusalas iela 101
LV1004 Rīga
Latvija
Phone +371 67 103 401
Fax +371 67 103 400
E-mail cservla@its.jnj.com

LITHUANIA

UAB JOHNSON & JOHNSON
Gelažinio Vilko g.18 A
Vilnius
LT-08104
Phone +370 52 636 162
Fax +370 52 755 008
E-mail cservlt@its.jnj.com

www.ethicon.com

